

MİMARİ KATALOG
ARCHITECTURAL CATALOGUE

Alüminyum Kapı Pencere ve Giydirme Cephe Sistemleri
Aluminium Window Doors and Facade Systems

RESCARA



RW46

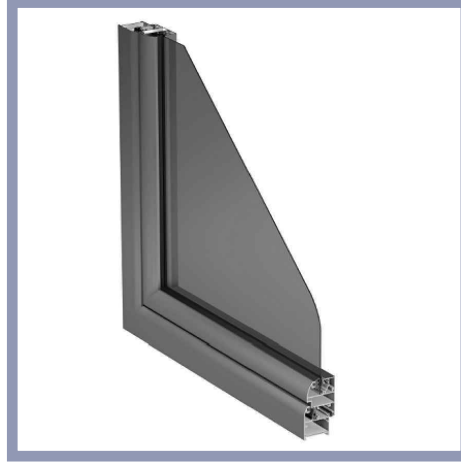

TEKNİK ÖZELLİKLER / TECHNICAL PROPERTIES

KASA DERİNLİĞİ / FRAME DEPTH	46 mm
KANAT DERİNLİĞİ / VENT DEPTH	51,6/46/51,2 mm
PROFİL ET KALINLIĞI / PROFILE WALL THICKNESS	1,4 mm
MAKS. CAM KALINLIĞI / MAX. GLASS THICKNESS	22 mm

UYGULAMA SEÇENEKLERİ / APPLICATION OPTIONS

	PENCERE WINDOW	KAPI DOOR
İÇE AÇILIR / INWARD OPENNING	•	•
VASİSTAS / BOTTOM HUNG	•	
DIŞA AÇILIR BİNİLİ / OUTWARD OPENNING		•
DIŞA-İÇE AÇILIR HEMYÜZ / INWARD-OUTWARD OPENNING COPLANAR		•
ÇİFT EKSEN AÇILIM / TILT & TURN OPENNING	•	•
PVC AKSESUARA UYGUN KANAT / VENT FOR PVC ACCESSORIES	•	•

MİMARİ KATALOG

ARCHITECTURAL CATALOGUE

Alüminyum Kapı Pencere ve Giydirme Cephe Sistemleri
Aluminium Window Doors and Facade Systems



Rescara Sistem Detayları
Rescara System Details

RW46

PROFİLLER

PROFILES

01

02

03

04

05

06

07

08

09

10

KOD / CODE	AĞIRLIK (kg/m) / WEIGHT	Jxx cm ⁴	Jyy cm ⁴	L m	
R46 F 01	0,827	8,533	5,419	6	
R46 F 02	1,003	11,918	18,074	6	
R46 F 03	0,907	9,939	8,264	6	
R46 F 05	0,914	9,556	8,853	6	

R46 F 01

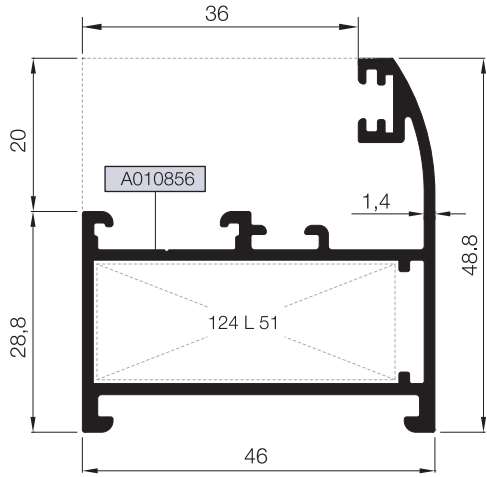

R46 F 02

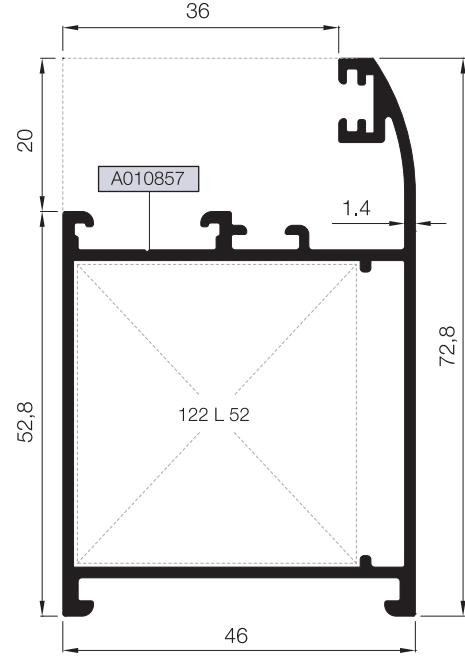

R46 F 03

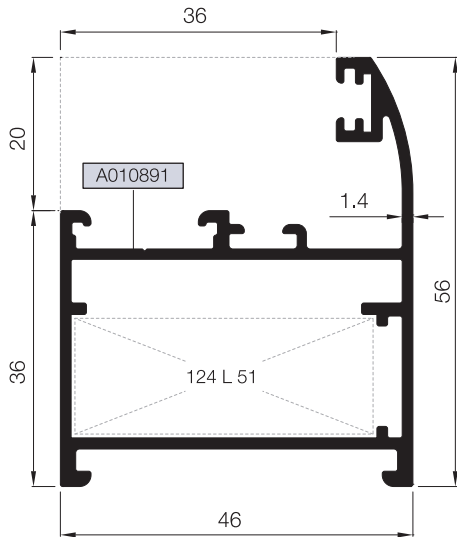

R46 F 05

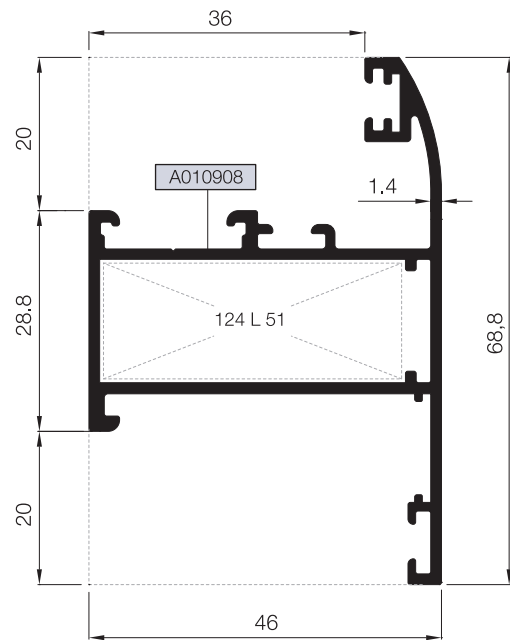

Nr		L m	KESİM ÖLÇÜSÜ CUTTING SIZE	AKS. KODU ACS. CODE
R46 F 01	A010856	25 L 51 (A010887)	39,3 mm	124 L 51
R46 F 03	A010891			
R46 F 05	A010908			
R46 F 02	A010857	25 L 52 (A010888)	36,7 mm	122 L 52

KOD / CODE	AĞIRLIK (kg/m) / WEIGHT	Jxx cm4	Jyy cm4	L m	
R46 V 01	1,011	11,784	9,210	6	
R46 V 02	1,190	15,826	26,390	6	
R46 V 05	1,315	19,086	46,297	6	

R46 V 01

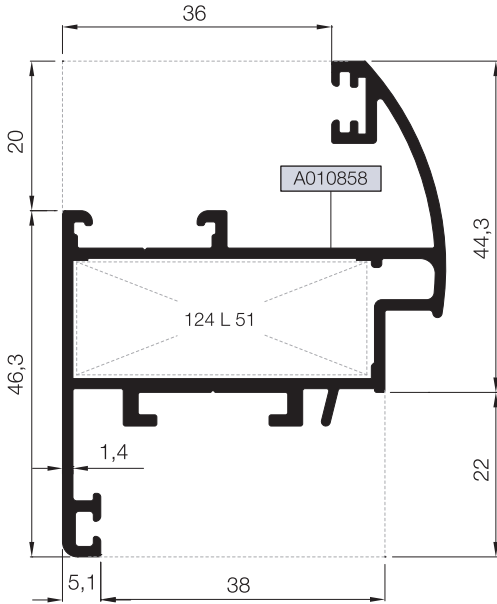

R46 V 02

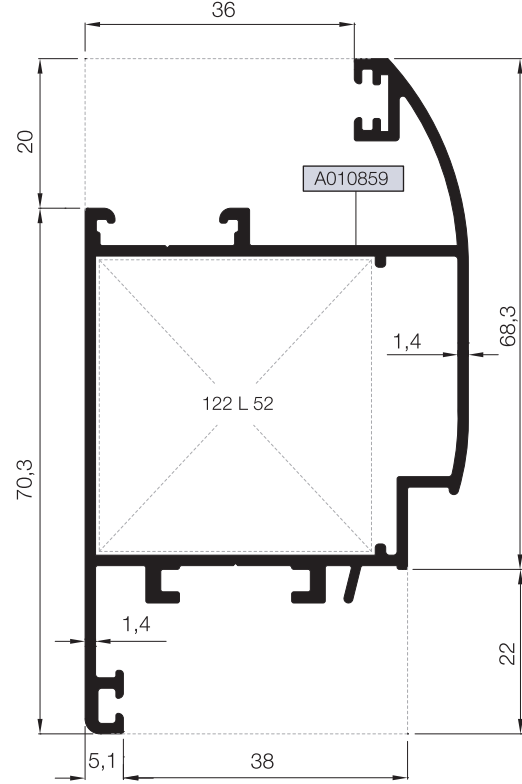

R46 V 05

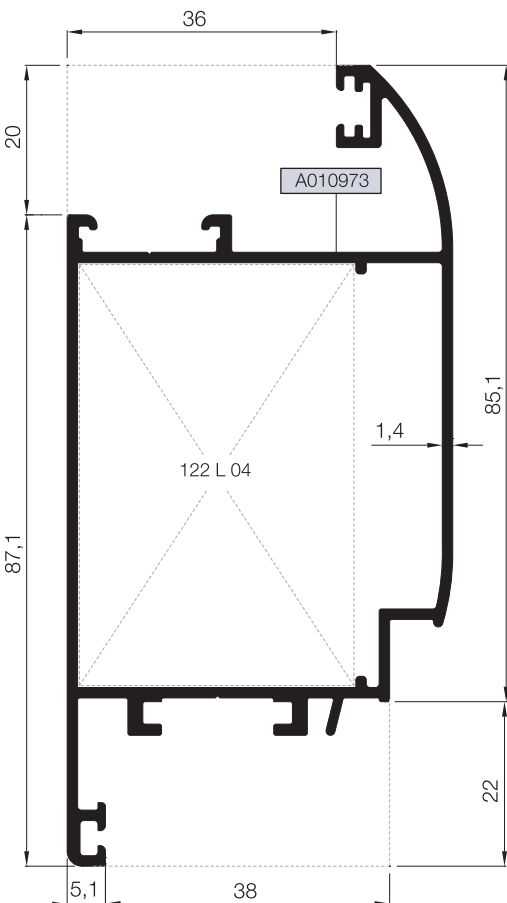

Nr		L m	KESİM ÖLÇÜSÜ CUTTING SIZE	AKS. KODU ACS. CODE
R46 V 01	A010858	25 L 51 (A010887)	39,3 mm	124 L 51
R46 V 02	A010859	25 L 52 (A010888)	36,7 mm	122 L 52
R46 V 05	A010973	25 L 04 (A002211)	36,7 mm	122 L 04

KOD / CODE	AĞIRLIK (kg/m) / WEIGHT	Jxx cm ⁴	Jyy cm ⁴	L m	
R46 V 03	1,204	15,071	37,926	6	
R46 V 04	1,204	14,263	37,934	6	

R46 V 03 (HEM YÜZ)

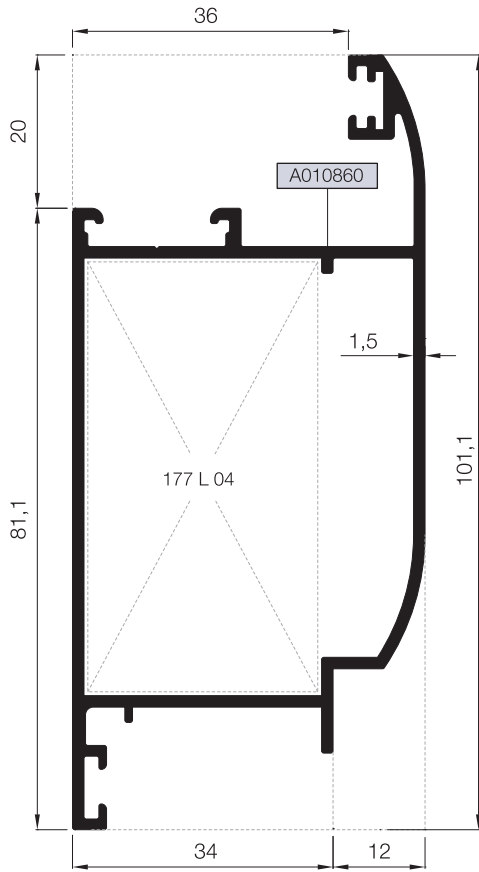

R46 V 04 (HEM YÜZ)

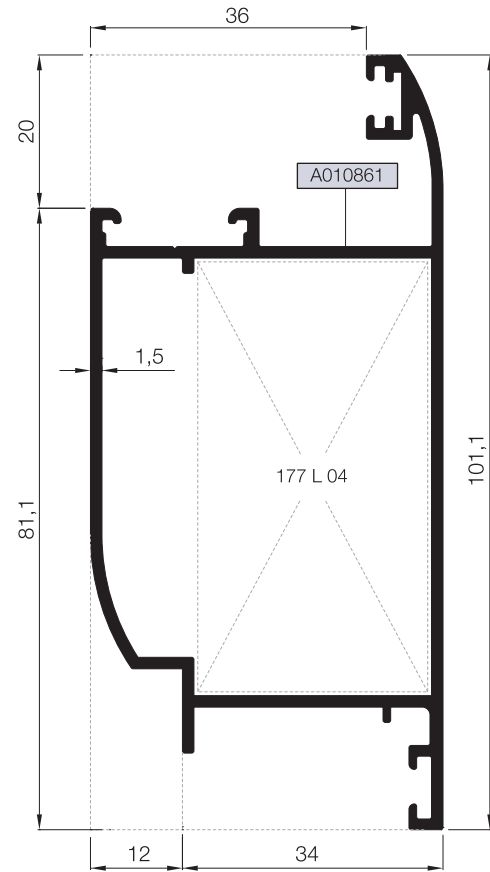

Nr		L m	KESİM ÖLÇÜSÜ CUTTING SIZE	AKS. KODU ACS. CODE
R46 V 03	A010860	25 L 04 (A002211)	30,7 mm	177 L 04
R46 V 04	A010861	25 L 04 (A002211)	30,7 mm	177 L 04

KANAT VE ADAPTÖR PROFİLLERİ (PVC AKSESUAR UYGUN - 9 AKS)
VENT AND ADAPTER PROFILES (FOR PVC ACCESSORY - 9 AXLE)

RW46

KOD / CODE	AĞIRLIK (kg/m) / WEIGHT	Jxx cm ⁴	Jyy cm ⁴	L m	
R46 V 06	1,447	20,376	47,869	6	
R46 V 07	1,216	15,044	19,012	6	
R46 A 13	0,856	---	---	6	

R46 V 06

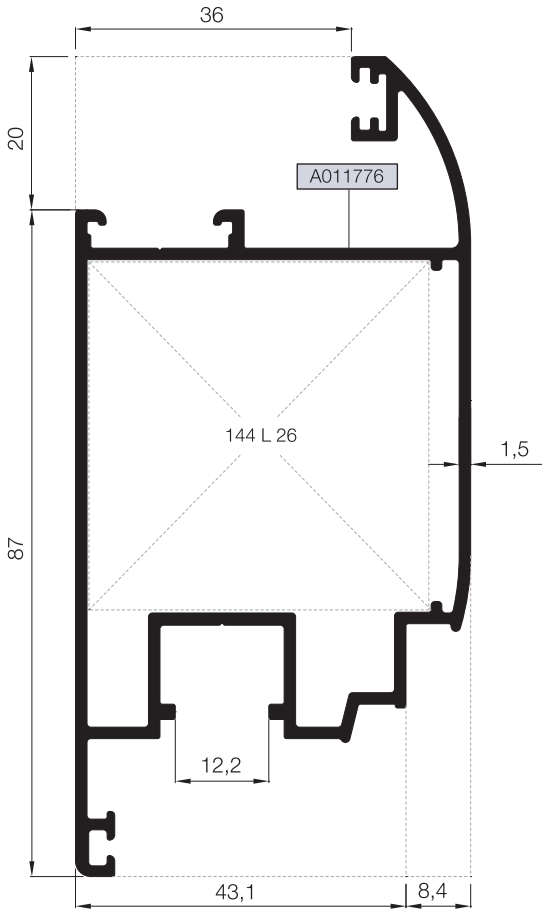

R46 V 07

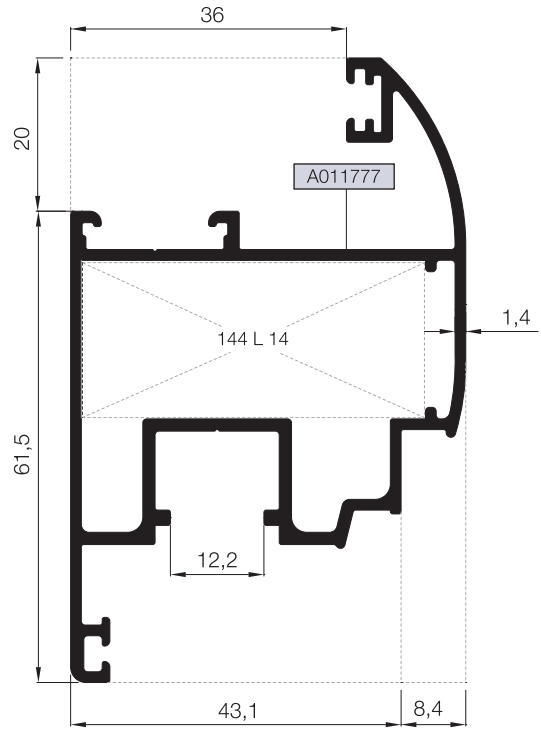

R46 A 13

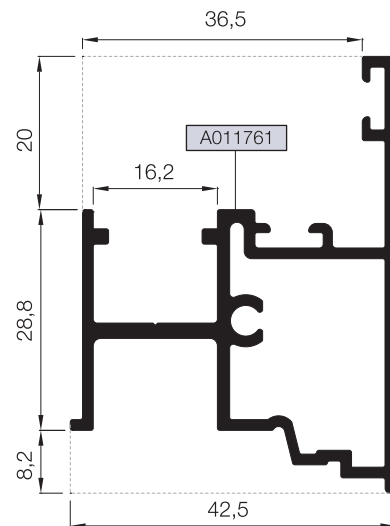

Nr		L m	KESİM ÖLÇÜSÜ CUTTING SIZE	AKS. KODU ACS. CODE
R46 V 06	A011776	25 L 26 (A010540)	44,4 mm	144 L 26
R46 V 07	A011777	25 L 14 (A002059)	44,4 mm	144 L 14

KOD / CODE	AĞIRLIK (kg/m) / WEIGHT	Jxx cm ⁴	Jyy cm ⁴	L m	
R46 M 01	0,975	7,752	8,326	6	
R46 M 02	1,128	9,905	21,308	6	
R46 M 03	1,019	9,241	20,224	6	

R46 M 01

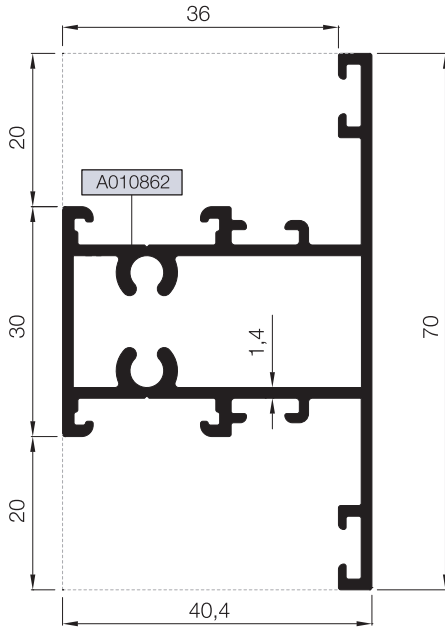

R46 M 03

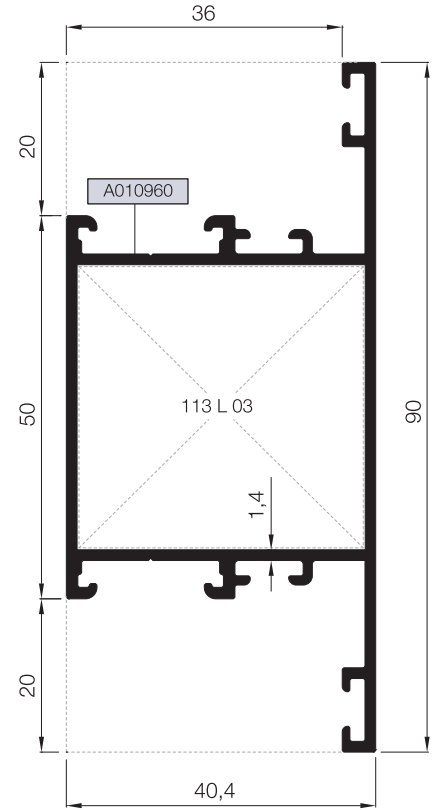

R46 M 02

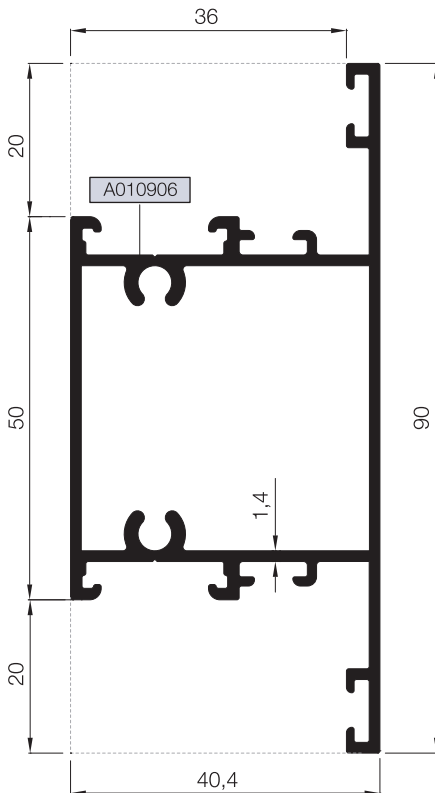

Nr		L m	KESİM ÖLÇÜSÜ CUTTING SIZE	AKS. KODU ACS. CODE
R46 M 03	A010960	25 L 03 (A002021)	37,1 mm	113 L 03

ETEK, ADAPTÖR VE TİJ PROFİLLERİ
KICK PLATE, ADAPTER AND SLIDING ROD PROFILES

RW46

KOD / CODE	AĞIRLIK (kg/m) / WEIGHT	Jxx cm ⁴	Jyy cm ⁴	L m	
R46 K 01	1,353	14,112	65,392	6	
R46 A 02	0,825	5,976	7,239	6	
R46 A 03	0,473	---	---	6	
25 I 07	0,143	---	---	6	
25 I 04	0,153	---	---	6	

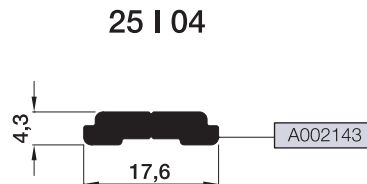
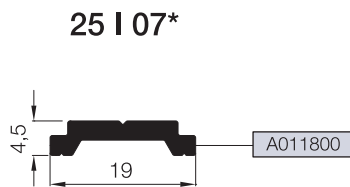
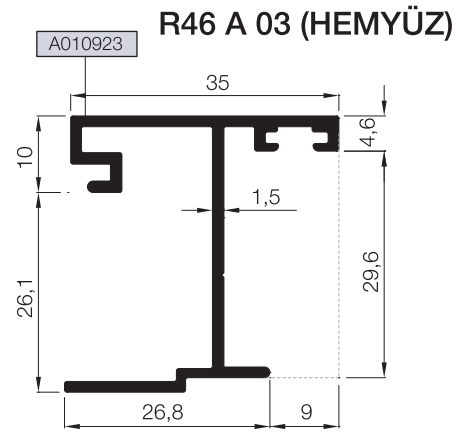
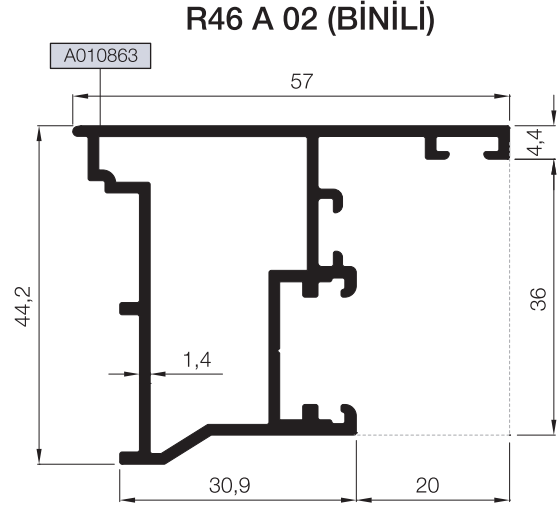
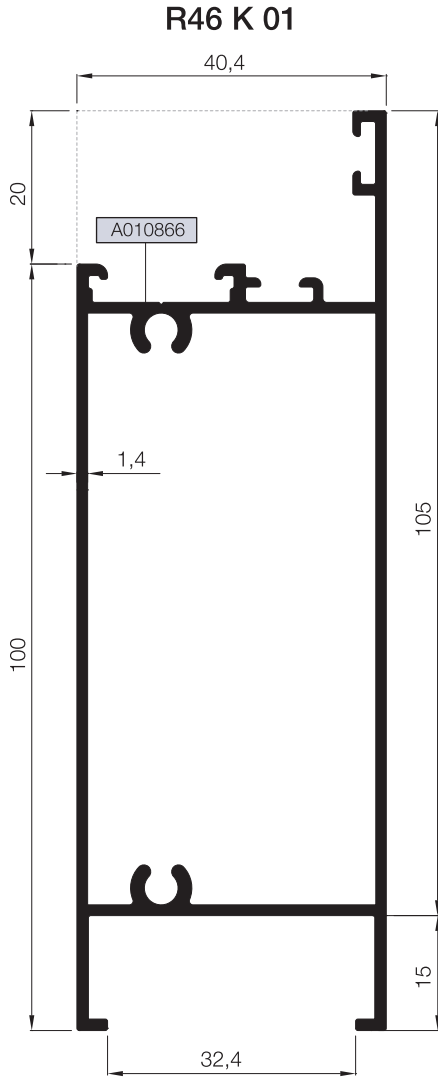

*Giесе kol ve kilitleme aksesuarları sadece 25 I 07 tij profili ile kullanılmalıdır.
Giесе handle and locking accessories should be used with only 25 I 07 rod profile

ADAPTÖR PROFİLLERİ ADAPTER PROFILES

RW46

KOD / CODE	AĞIRLIK (kg/m) / WEIGHT	Jxx cm4	Jyy cm4	L m	
R46 A 04	0,229	---	---	6	
R46 A 07	0,475	---	---	6	
R46 A 12	0,686	---	---	6	

R46 A 04

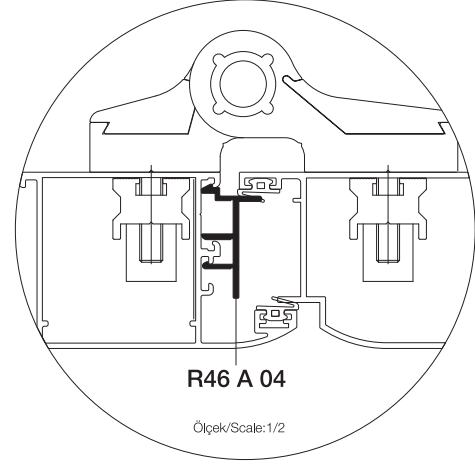
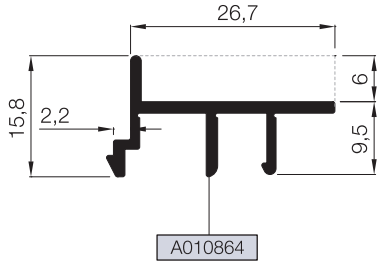

R46 A 07

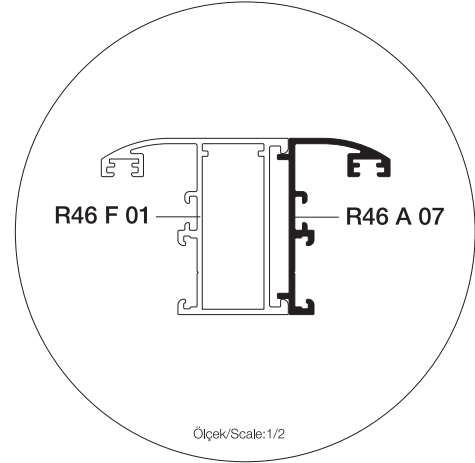
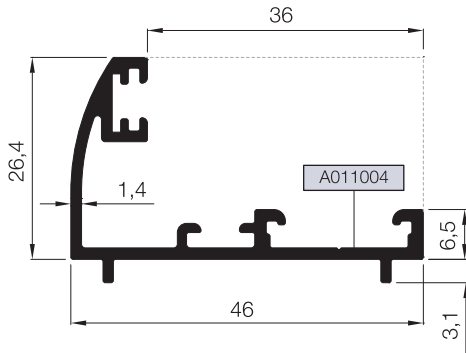

R46 A 12

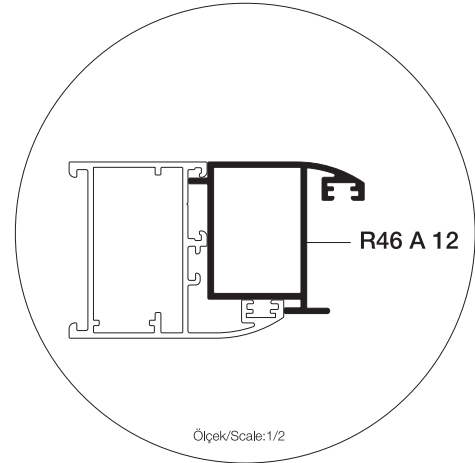
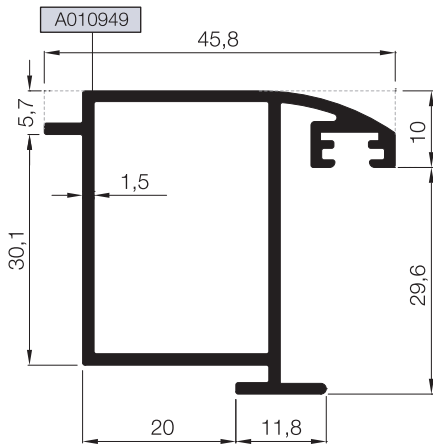

ADAPTÖR PROFİLLERİ
ADAPTER PROFILES

RW46

KOD / CODE	AĞIRLIK (kg/m) / WEIGHT	Jxx cm4	Jyy cm4	L m	
R46 A 09	0,417	---	---	6	
A001185	0,556	---	---	6	
46 D 01	0,902	---	---	6	

R46 A 09

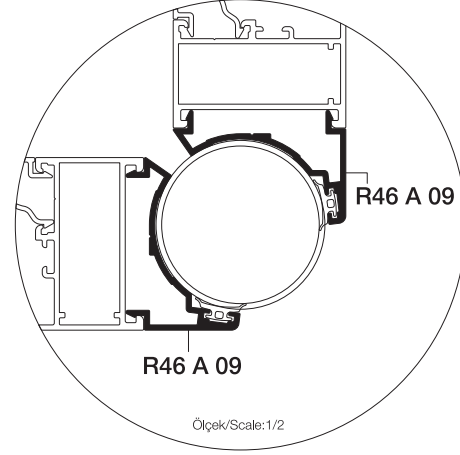
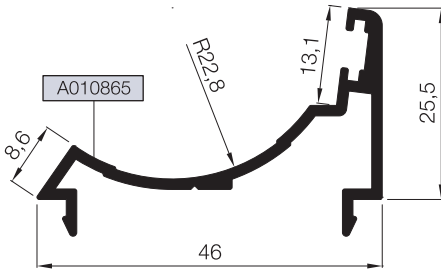

A001185

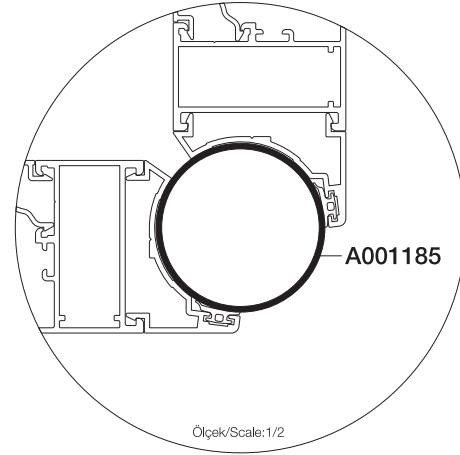
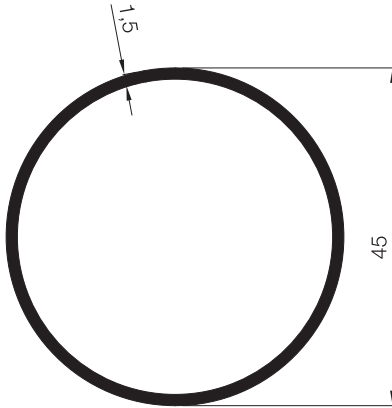

46 D 01

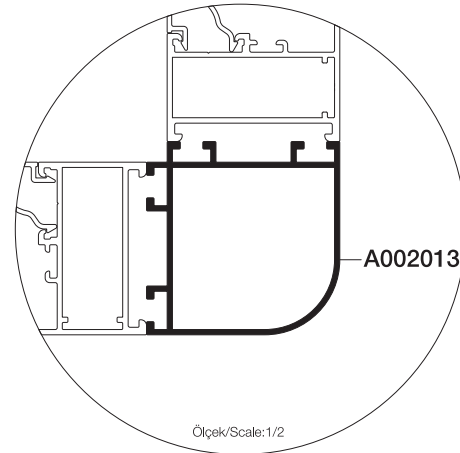
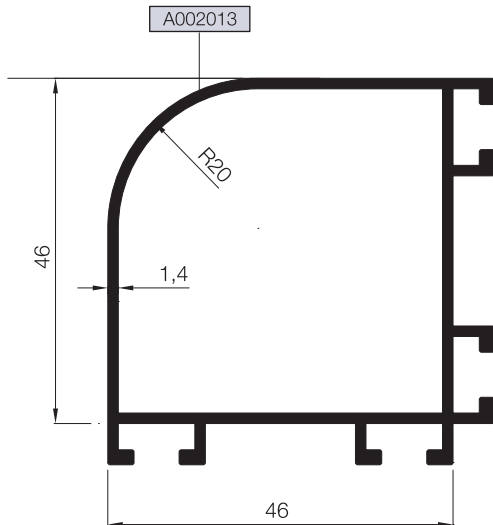

ADAPTÖR PROFİLLERİ ADAPTER PROFILES

RW46

KOD / CODE	AĞIRLIK (kg/m) / WEIGHT	Jxx cm4	Jyy cm4	L m	
46 D 02	0,794	---	---	6	
46 A 10	0,398	---	---	6	
46 A 08	0,354	---	---	6	

46 D 02

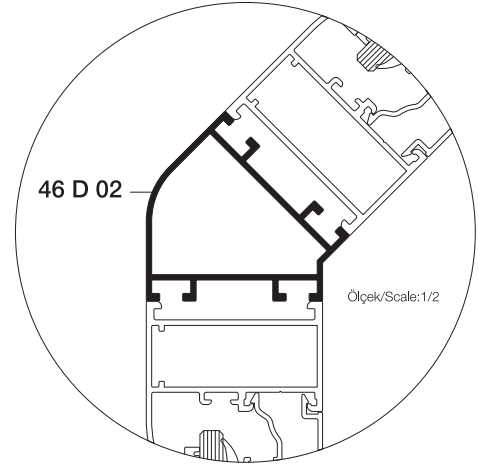
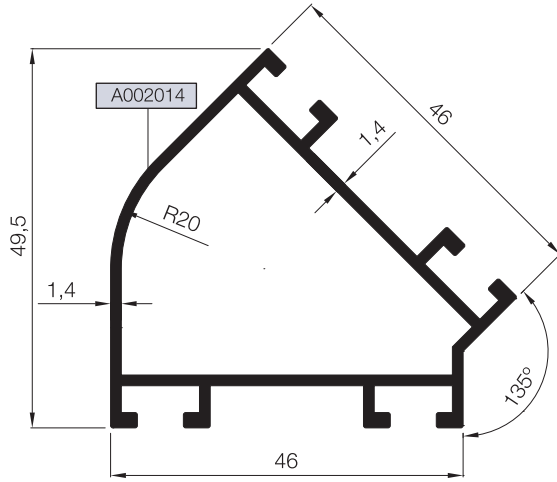

46 A 10

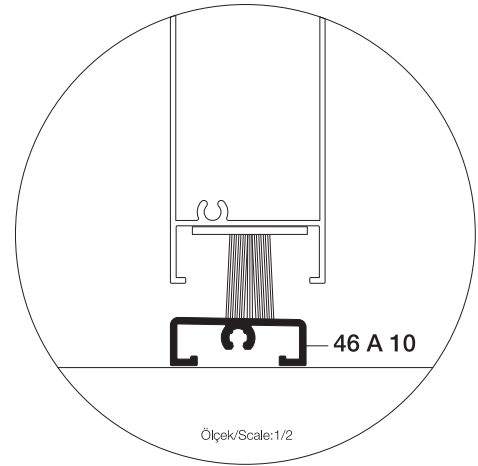
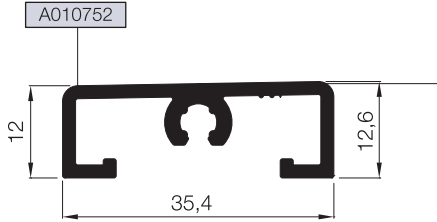

46 A 08

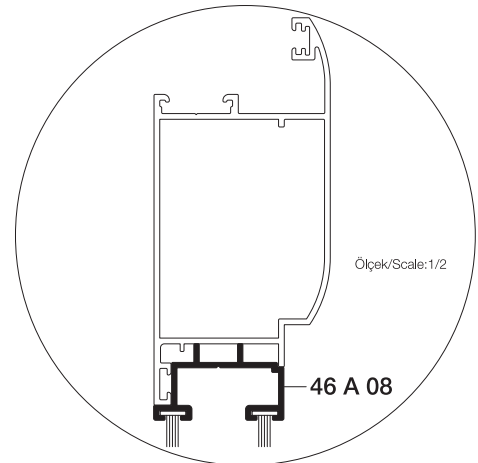
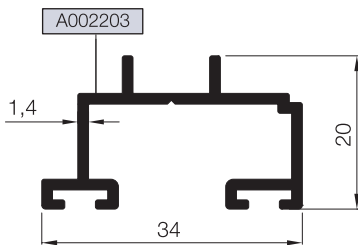

KOD / CODE	AĞIRLIK (kg/m) / WEIGHT	L m	KOD / CODE	AĞIRLIK (kg/m) / WEIGHT	L m
25 G 21	0,196	6	25 G 12	0,270	6
25 G 28	0,218	6	25 G 13	0,278	6
25 G 11	0,224	6	25 G 14	0,280	6
25 G 10	0,225	6	25 G 15	0,282	6
25 G 09	0,229	6			

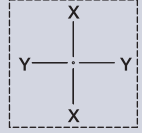

25 G 21

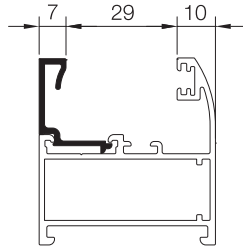
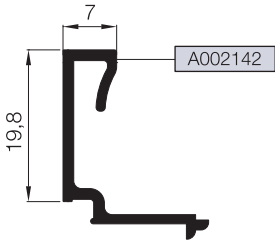

25 G 12

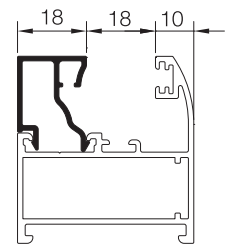
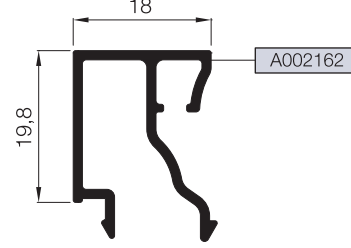

25 G 28

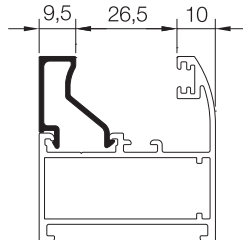
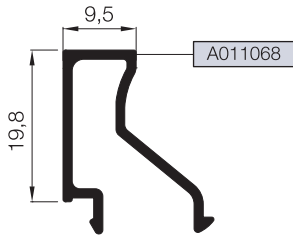

25 G 13

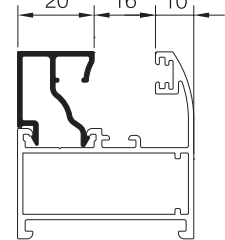
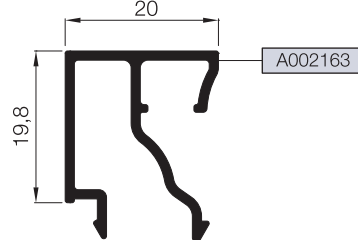

25 G 11

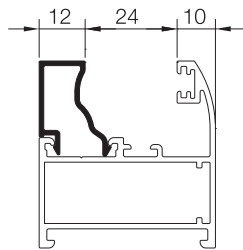
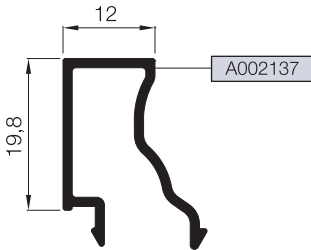

25 G 14

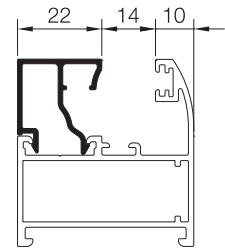
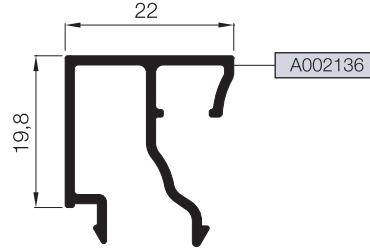

25 G 10

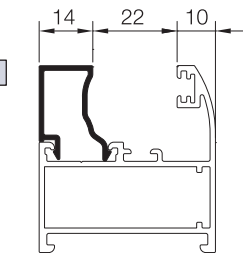
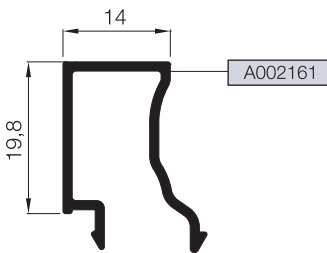

25 G 15

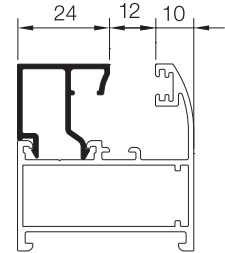
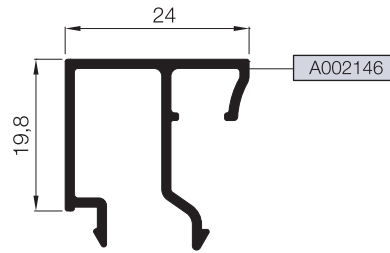

25 G 09

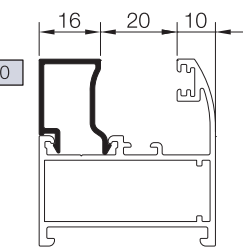
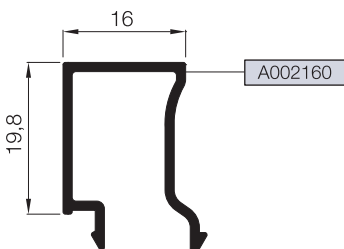

01

02

03

04

05

06

07

08

09

10

B CAM ÇİTASI GLAZING BEAD	C İÇ CAM FİTİLİ GLAZING GASKET (IN)	A CAM KALINLIĞI GLASS THICKNESS	D DIŞ CAM FİTİLİ GLAZING GASKET (OUT)
25 G 15	01.17.04	4 mm	01.11.15
25 G 15	01.17.03	5 mm	01.11.15
25 G 14	01.17.04	6 mm	01.11.15
25 G 14	01.17.03	7 mm	01.11.15
25 G 13	01.17.04	8 mm	01.11.15
25 G 13	01.17.03	9 mm	01.11.15
25 G 12	01.17.04	10 mm	01.11.15
25 G 12	01.17.03	11 mm	01.11.15
25 G 09	01.17.04	12 mm	01.11.15
25 G 09	01.17.03	13 mm	01.11.15
25 G 10	01.17.04	14 mm	01.11.15
25 G 10	01.17.03	15 mm	01.11.15
25 G 11	01.17.04	16 mm	01.11.15
25 G 11	01.17.03	17 mm	01.11.15
25 G 28	01.17.05	18 mm	01.11.15
25 G 28	01.17.04	19 mm	01.11.15
25 G 21	01.17.05	20 mm	01.11.15
25 G 21	01.17.04	21 mm	01.11.15
25 G 21	01.17.03	22 mm	01.11.15

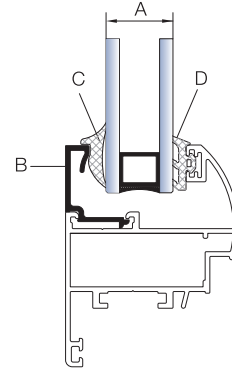
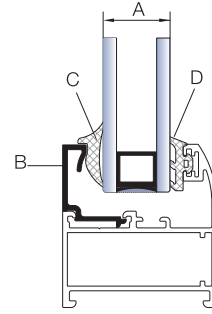

RW46

KÖŞE TAKOZLARI VE ORTA KAYIT BAĞLANTI (CORNER CLEAT AND MULLION CONNECTION CLEAT)

PROFİL KODU (PROFILE CODE)	25 L 03	25 L 04	25 L 51	25 L 52	25 J 13
FABRİKA KODU (FACTORY CODE)	A002021	A002211	A010887	A010888	A010959
AĞIRLIK (WEIGHT)	4,315 kg/m	7,711 kg/m	4,409 kg/m	4,377 kg/m	0,950 kg/m
ÇİZİM (DRAWING)					

PROFİL KODU (PROFILE CODE)	25 L 14	25 L 26
FABRİKA KODU (FACTORY CODE)	A002059	A010540
AĞIRLIK (WEIGHT)	3,270 kg/m	4,870 kg/m
ÇİZİM (DRAWING)		

Nr			KESİM ÖLÇÜSÜ CUTTING SIZE	AKS. KODU ACS. CODE
R46 F 01	A010856	25 L 51 (A010887)	39,3 mm	124 L 51
R46 F 03	A010891			
R46 F 05	A010908			
R46 F 02	A010857	25 L 52 (A010888)	36,7 mm	122 L 52
R46 V 01	A010858	25 L 51 (A010887)	39,3 mm	124 L 51
R46 V 02	A010859	25 L 52 (A010888)	36,7 mm	122 L 52
R46 V 03	A010860	25 L 04 (A002211)	30,7 mm	177 L 04
R46 V 04	A010861			
R46 V 05	A010973	25 L 04 (A002211)	36,7 mm	122 L 04
R46 M 03	A010960	25 L 03 (A002021)	37,1 mm	113 L 03
R46 V 06	A011776	25 L 26 (A010540)	44,4 mm	144 L 26
R46 V 07	A011777	25 L 14 (A002059)	44,4 mm	144 L 14
Nr			KESİM ÖLÇÜSÜ CUTTING SIZE	AKS. KODU ACS. CODE
R46 M 03	A010960	25 J 13 (A010959)	36,9 mm	307 J 13

STOKTA BULUNAN SİSTEM PROFİLLERİNİN LİSTESİ (LIST OF SYSTEM PROFILES IN STOCK)

Nr		MIN. SİPARİŞ MİKTARI MIN. ORDER QUANTITY
R46 F 02	A010857	75 kg
R46 M 01	A010862	75 kg
R46 K 01	A010866	75 kg

* STOKTA BULUNMAYAN TÜM PROFİLLER İÇİN MINİMUM SİPARİŞ MİKTARI 300*KG'DİR.
MINIMUM ORDER QUANTITY FOR ALL THE PROFILES THAT ARE NOT IN STOCK IS 300 KG.

MİMARİ KATALOG

ARCHITECTURAL CATALOGUE

Alüminyum Kapı Pencere ve Giydirme Cephe Sistemleri
Aluminium Window Doors and Facade Systems



Rescara Sistem Detayları
Rescara System Details

RW46

DETAYLAR

DETAILS

01

02

03

04

05

06

07

08

09

10

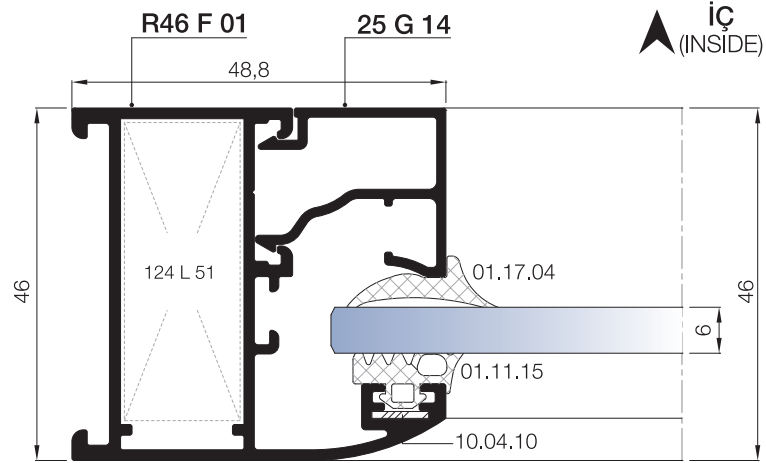
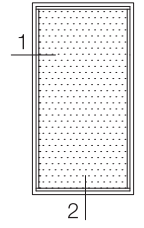

① DETAYI
DETAIL

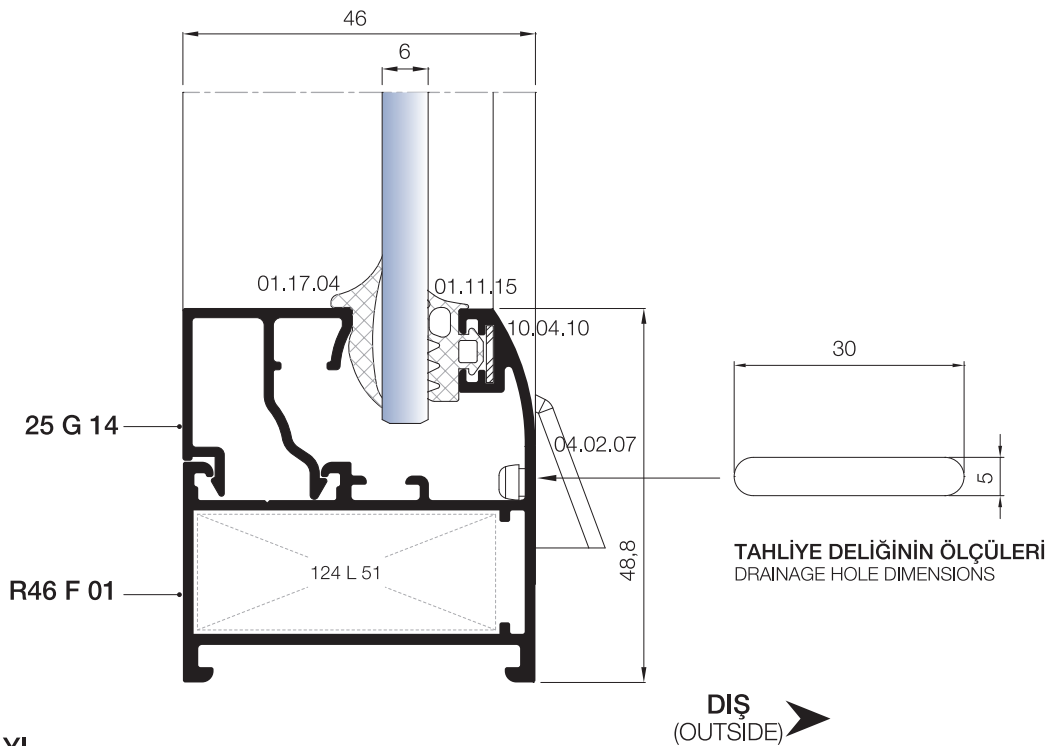

② DETAYI
DETAIL

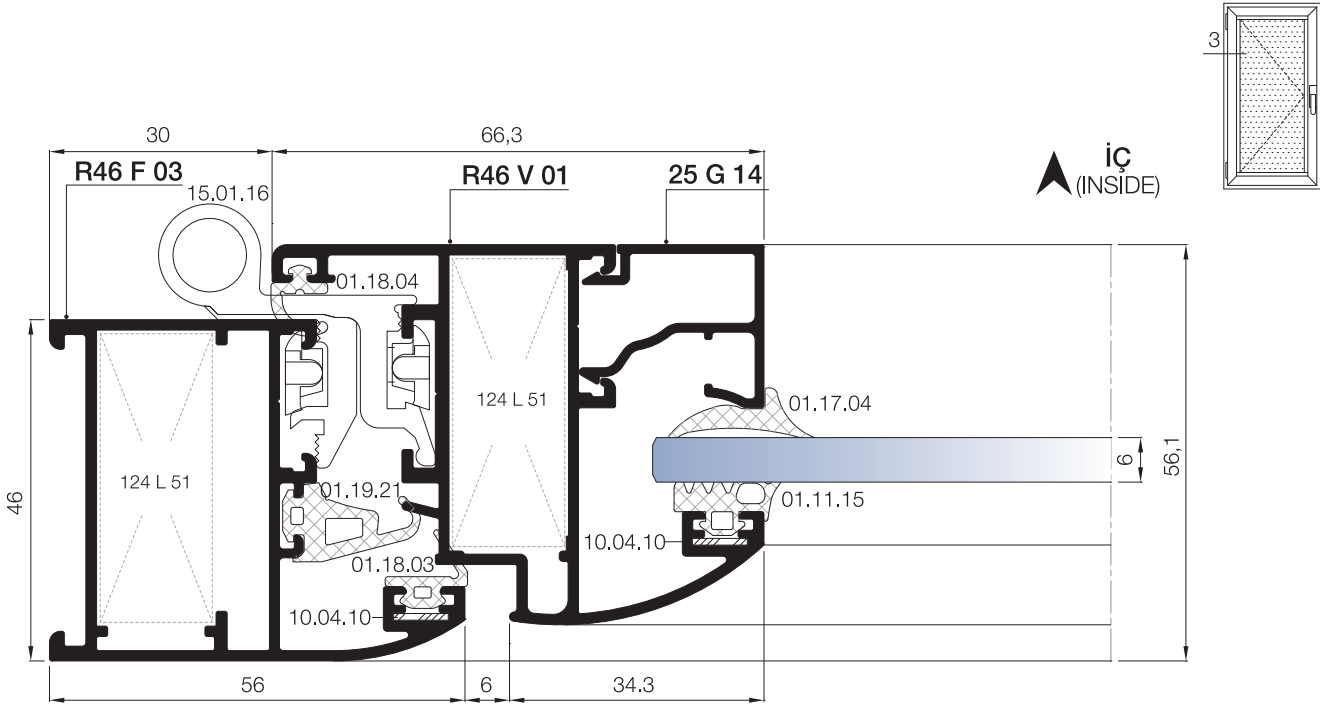

③ DETAYI
DETAIL

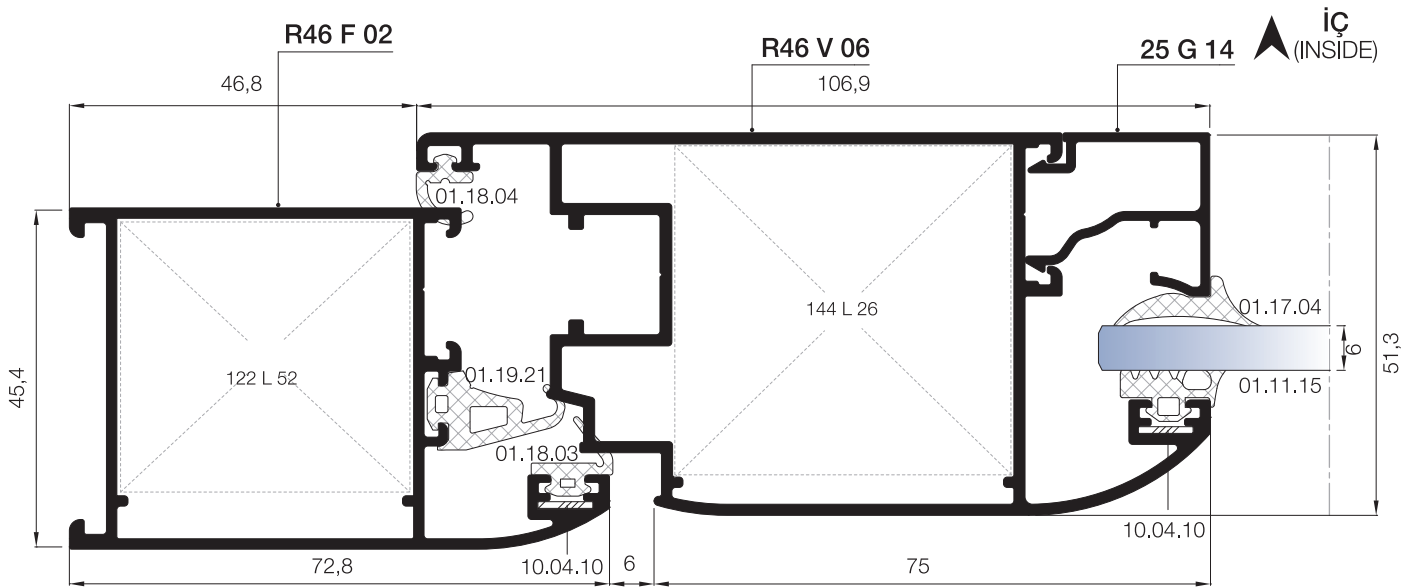

PVC AÇILIM AKSESUARINA UYGUN KANAT DETAYI
VENT DETAIL FOR PVC OPENNING ACCESSORIES

③A DETAYI
DETAIL

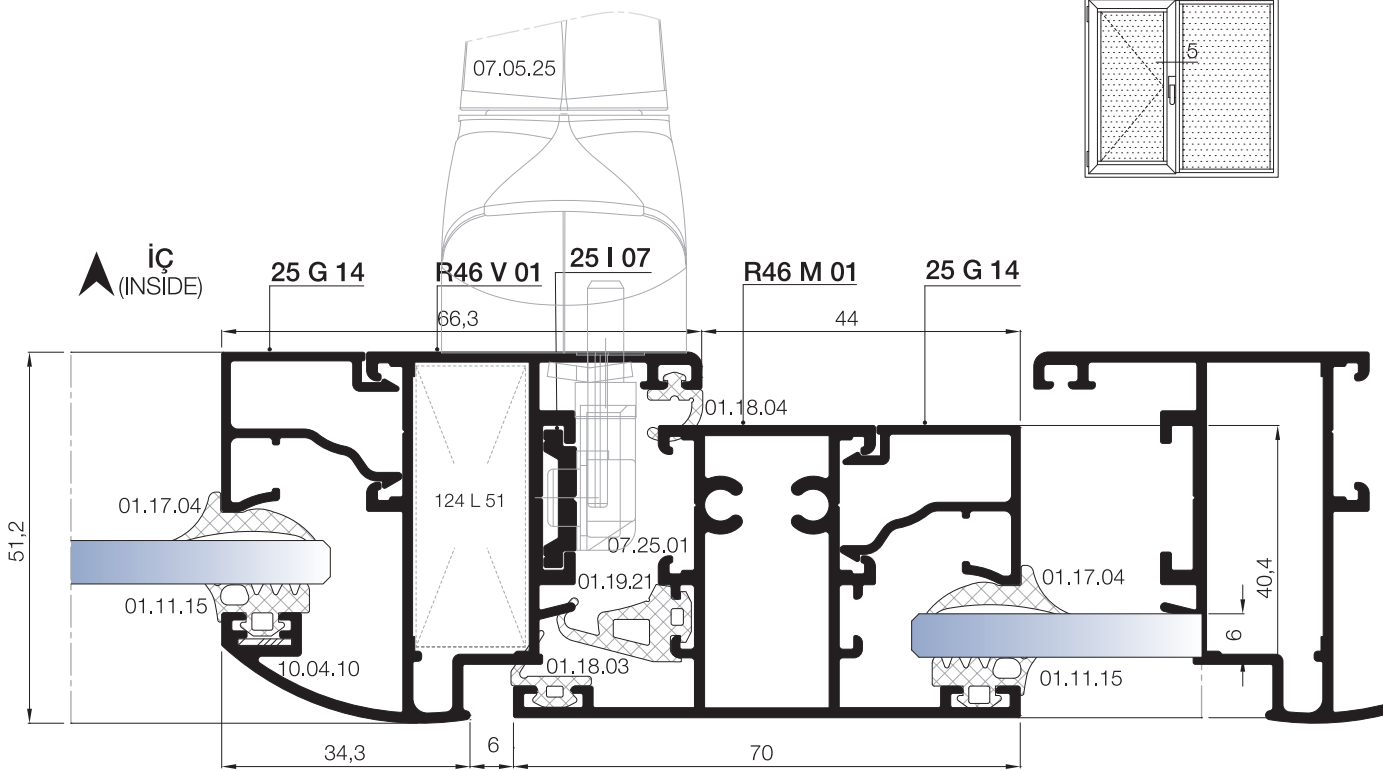
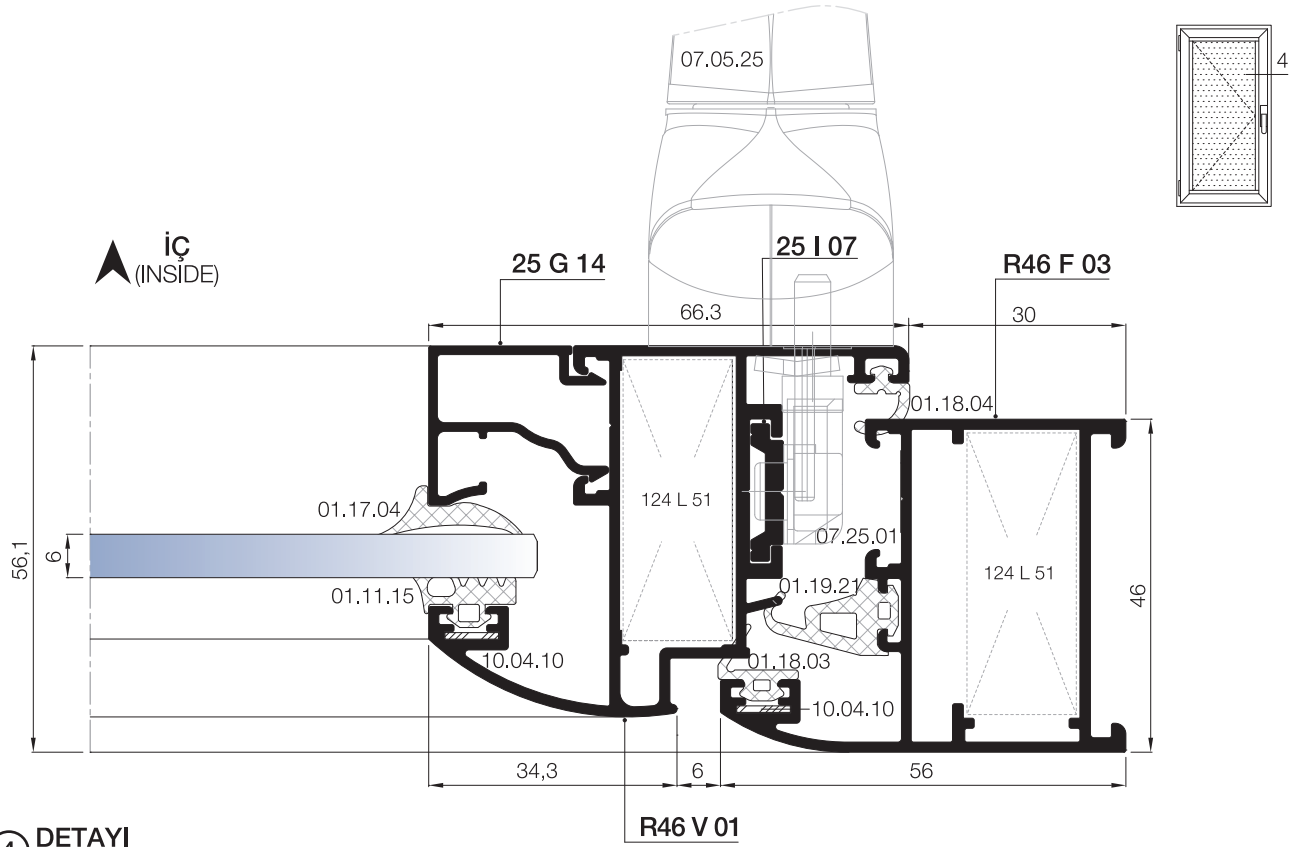

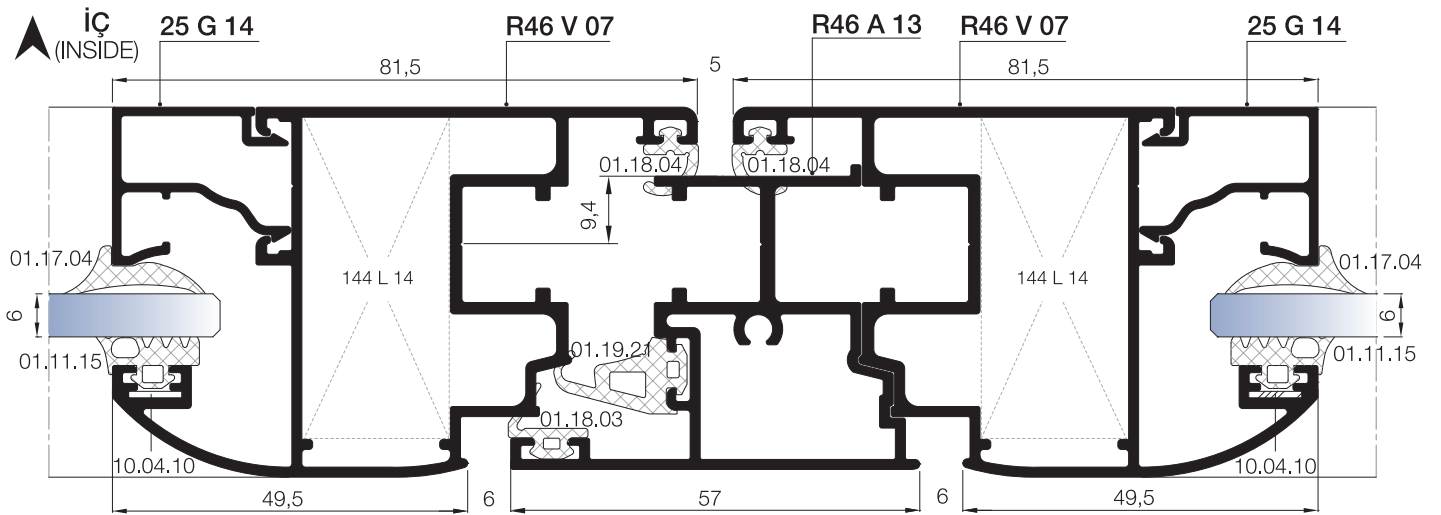
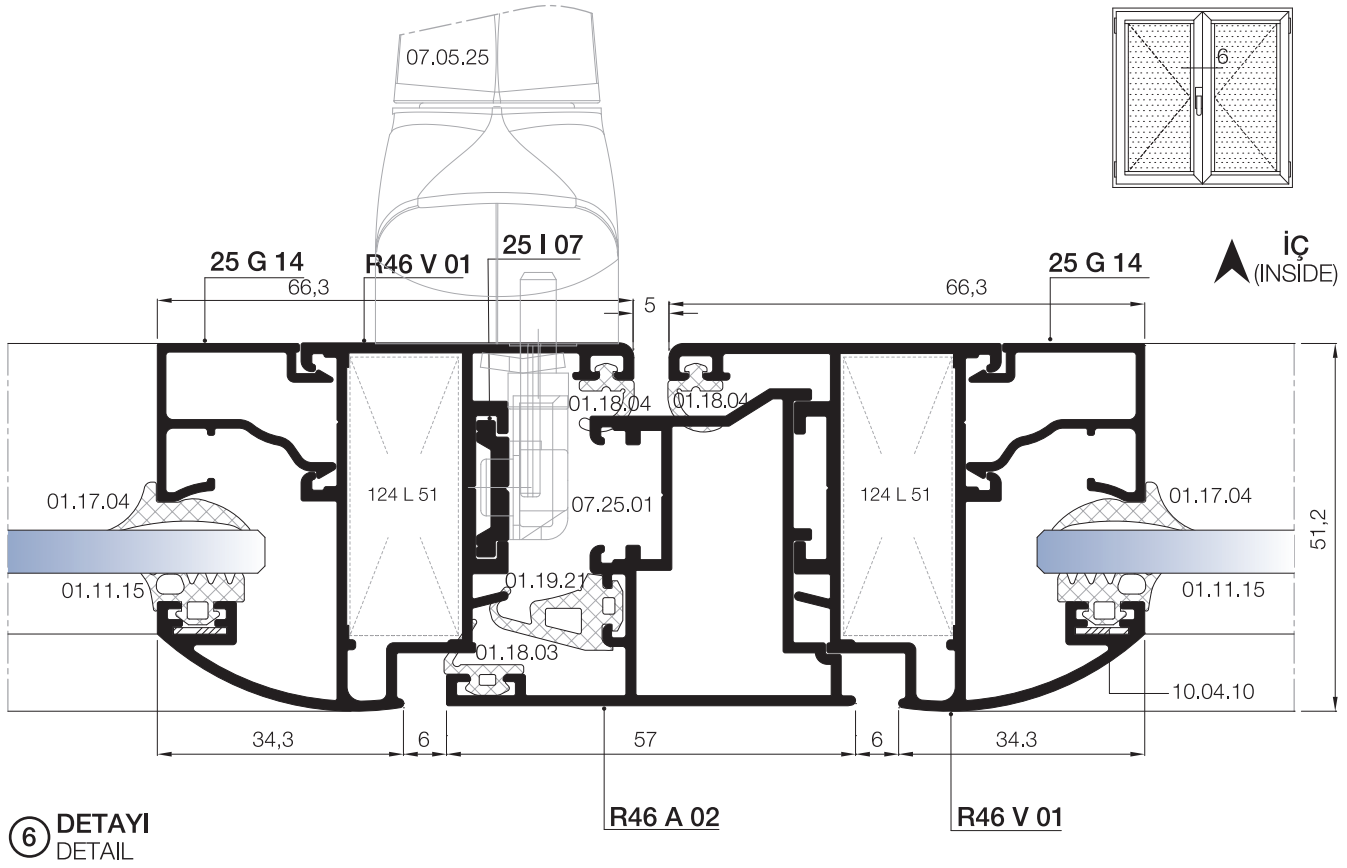

PVC AÇILIM AKSESUARINA UYGUN KANAT DETAYI
VENT DETAIL FOR PVC OPENING ACCESSORIES

6A DETAYI
DETAIL

İÇE AÇILIM BİNİLİ KAPI DETAYLARI
INWARD OPENING DOOR DETAILS

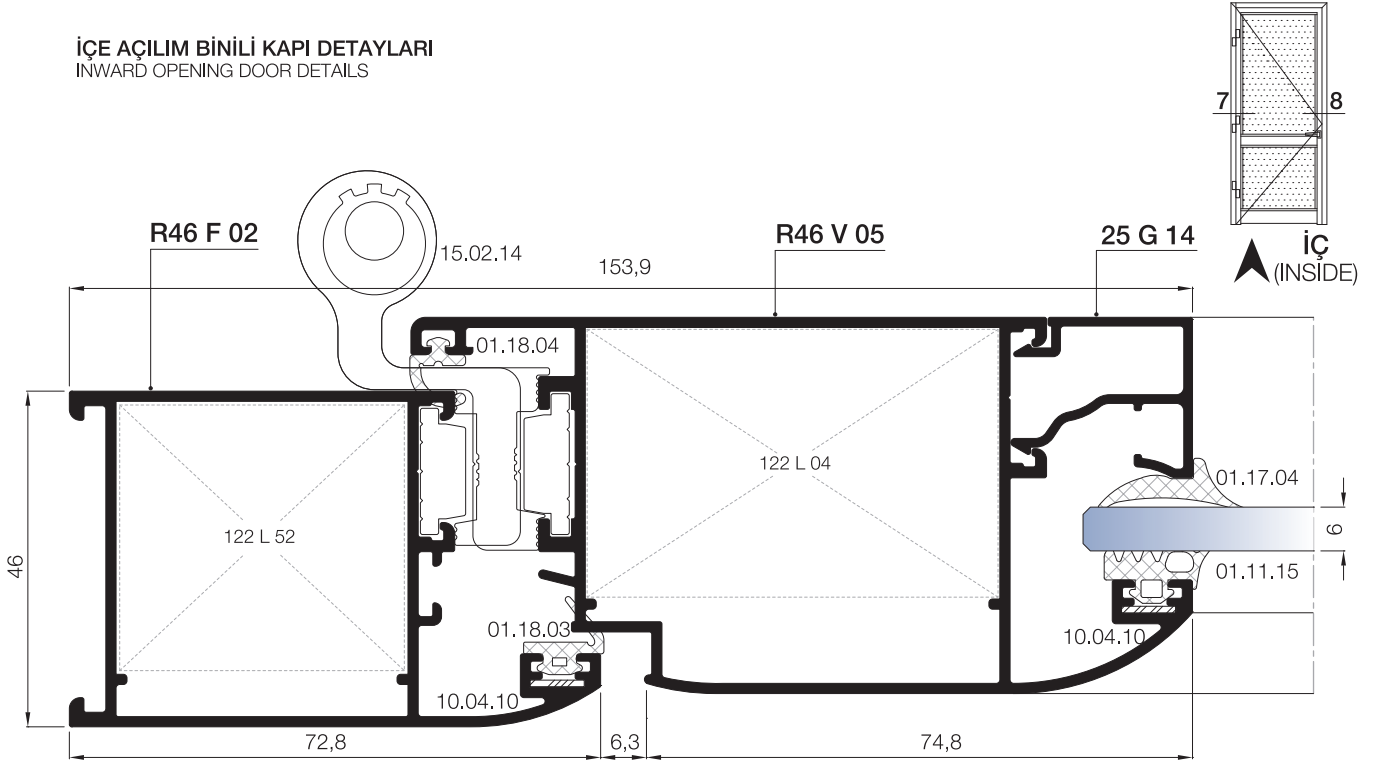

7 DETAYI
DETAIL

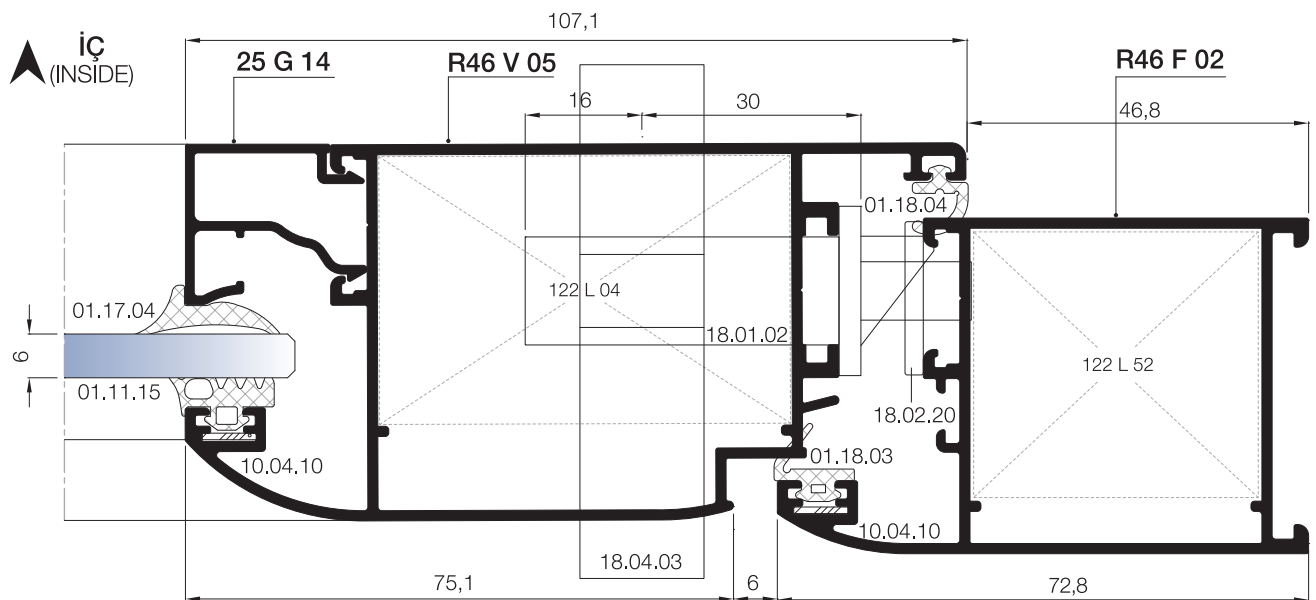

8 DETAYI
DETAIL

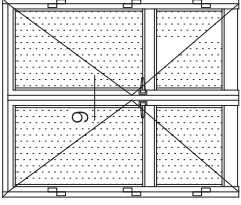

İÇE AÇILIM BİNİLİ KAPI DETAYLARI
INWARD OPENING DOOR DETAILS

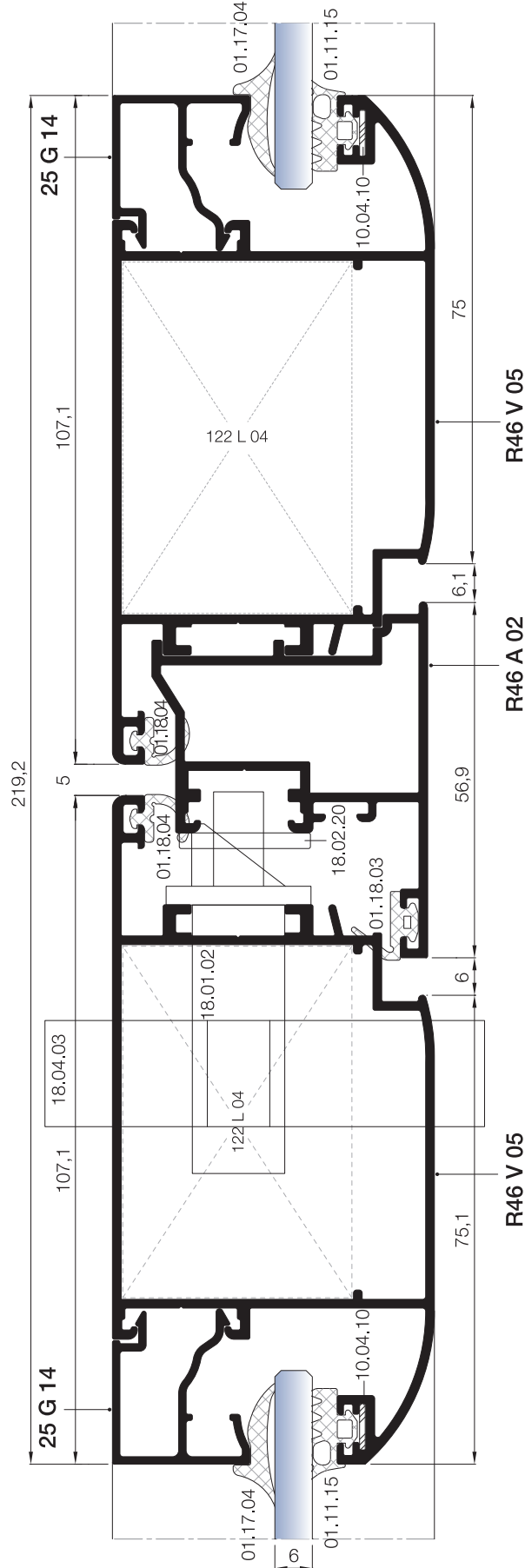

DIŞ
(OUTSIDE) ▼

İÇE AÇILIM HEMİYÜZ KAPI DETAYLARI
INWARD OPENING FLUSH DOOR DETAILS

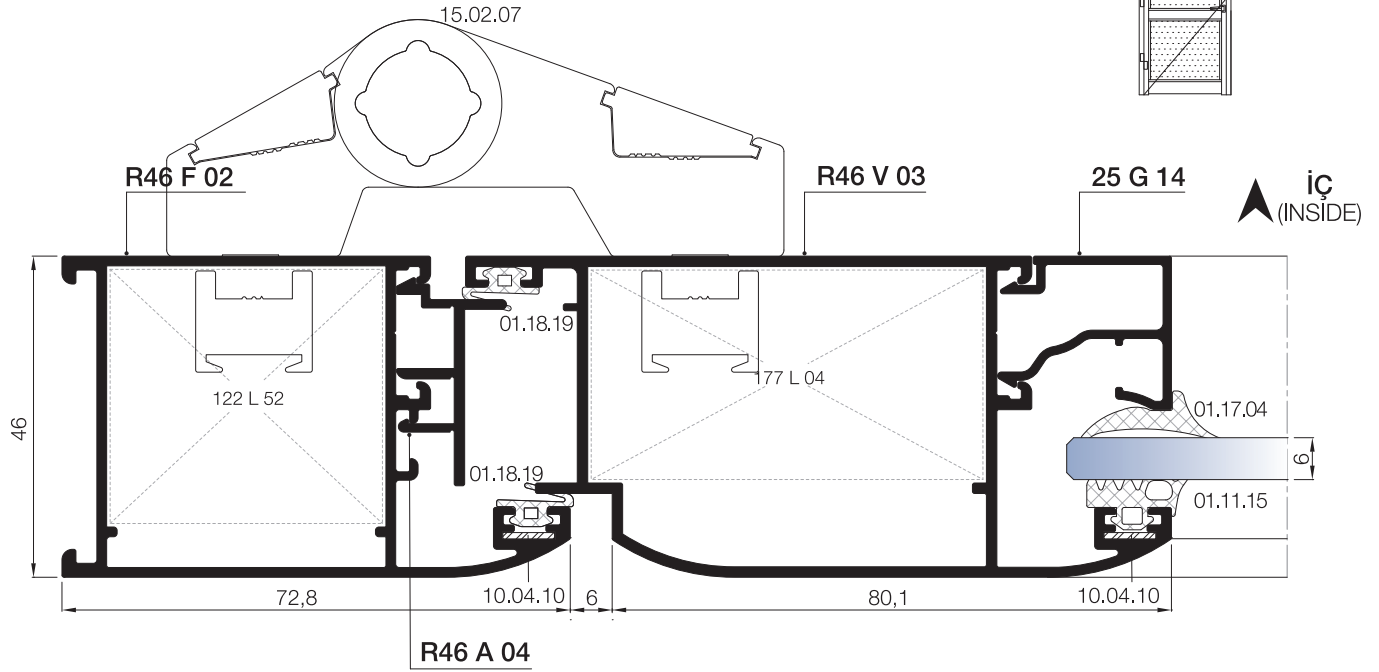

10 DETAYI
DETAIL

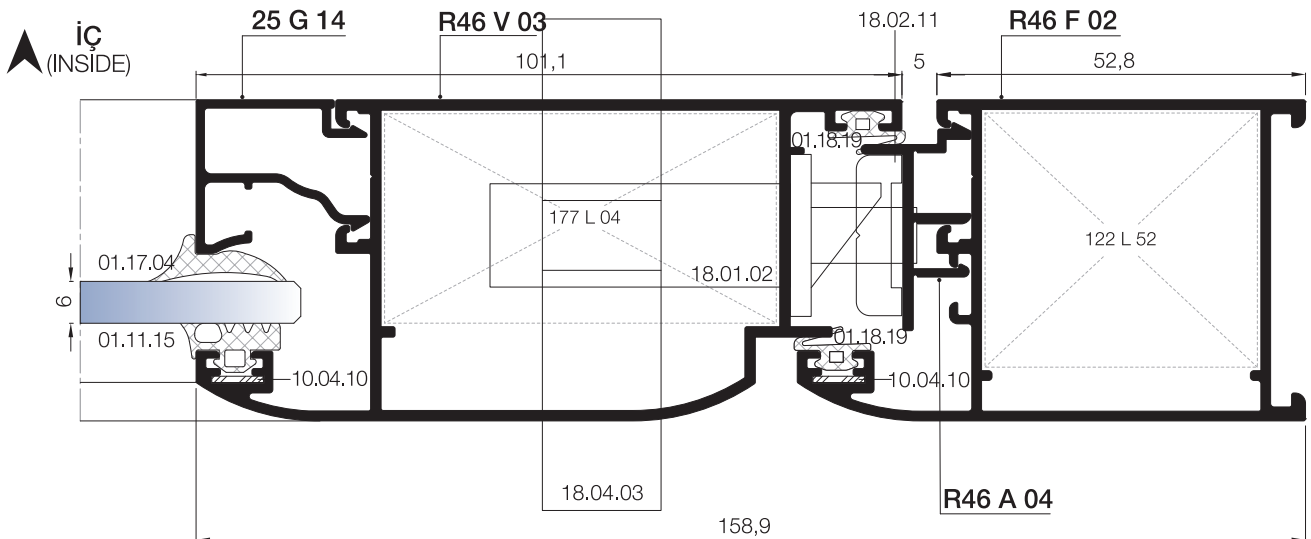

11 DETAYI
DETAIL

DIŐA AÇILIM HEMÜZ KAPI DETAYLARI
OUTWARD OPENING FLUSH DOOR DETAILS

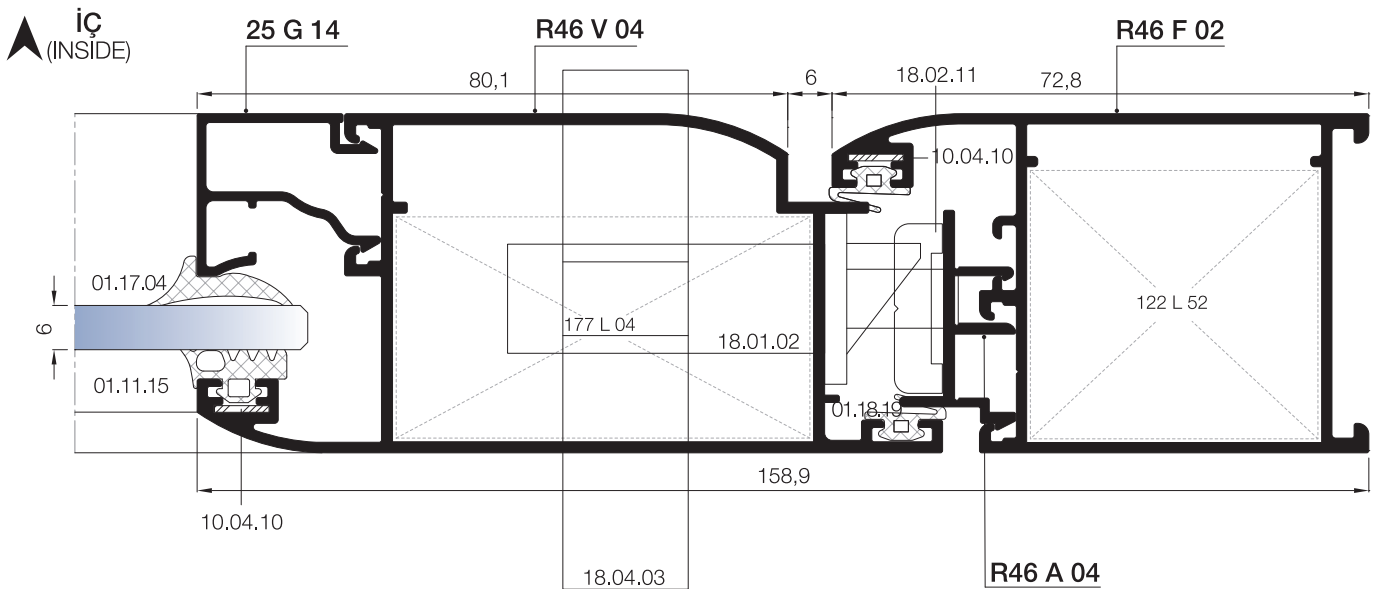
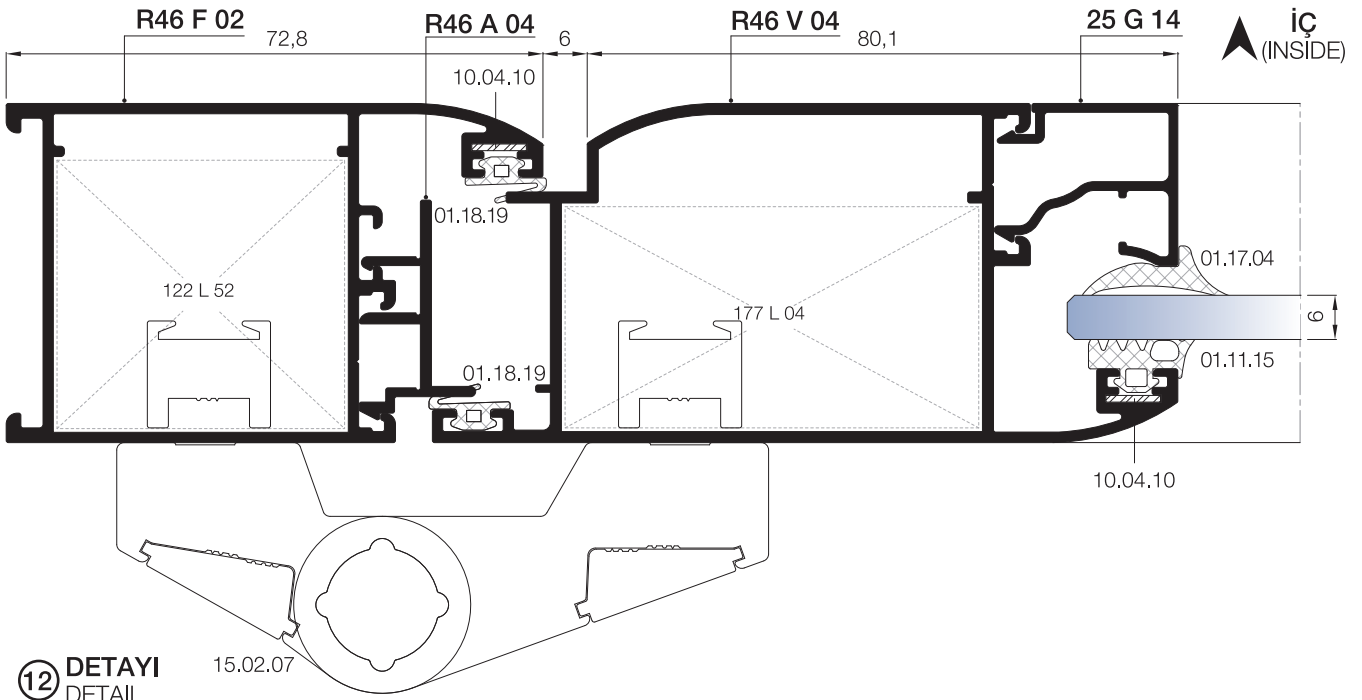
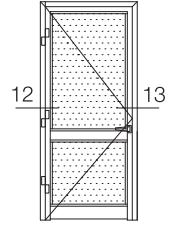

13 DETAYI
DETAIL

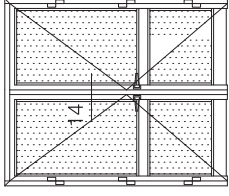

DİŐA AÇILIM HEMYÜZ KAPI DETAYLARI
OUTWARD OPENING FLUSH DOOR DETAILS

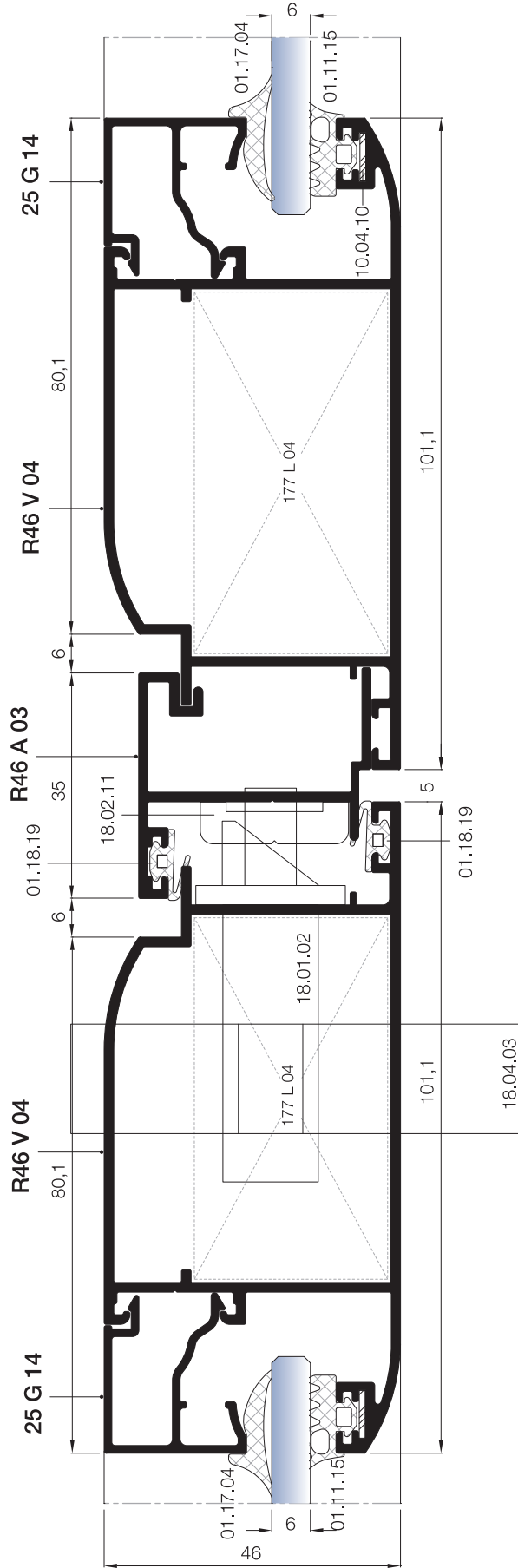

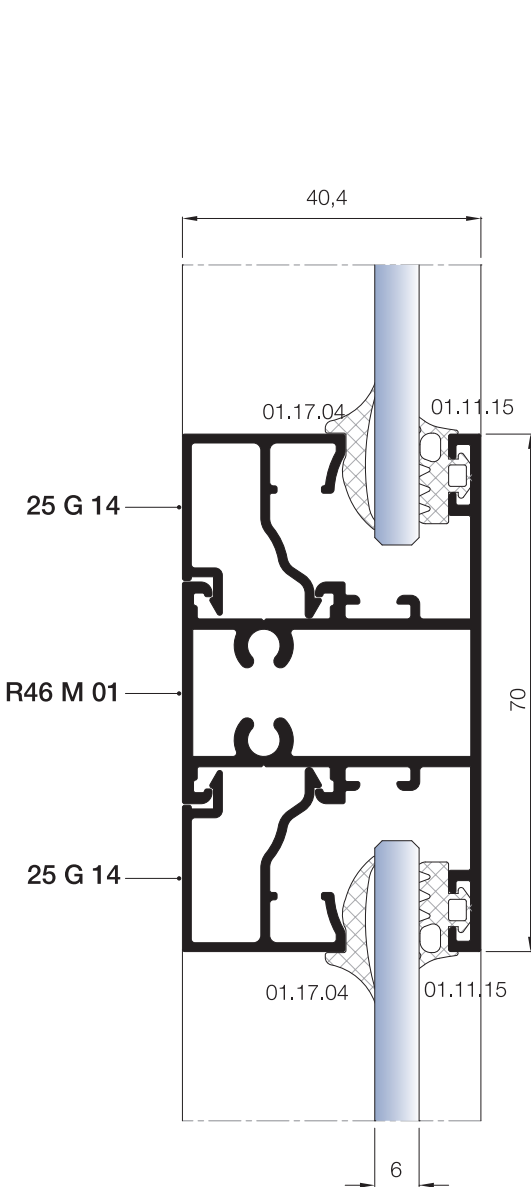
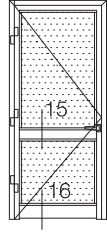

15 DETAYI
DETAIL

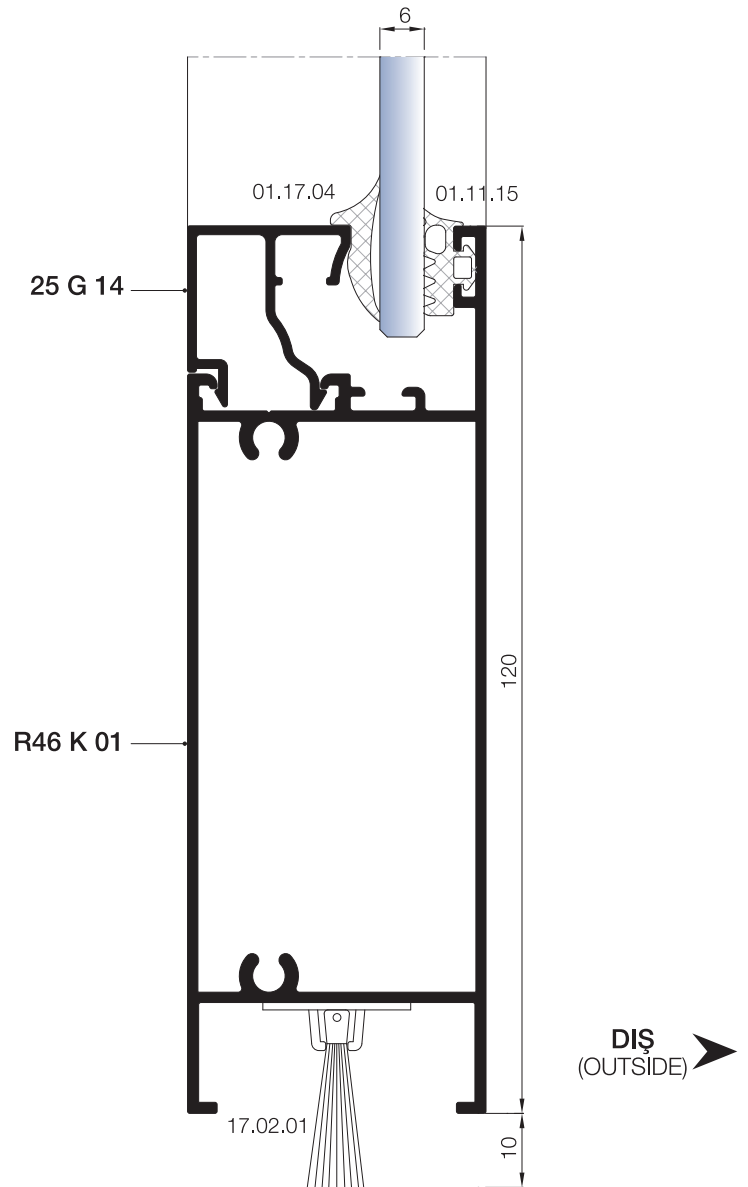

16 DETAYI
DETAIL

01

02

03

04

05

06

07

08

09

10

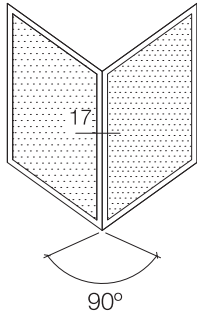

01

02

03

04

05

06

07

08

09

10

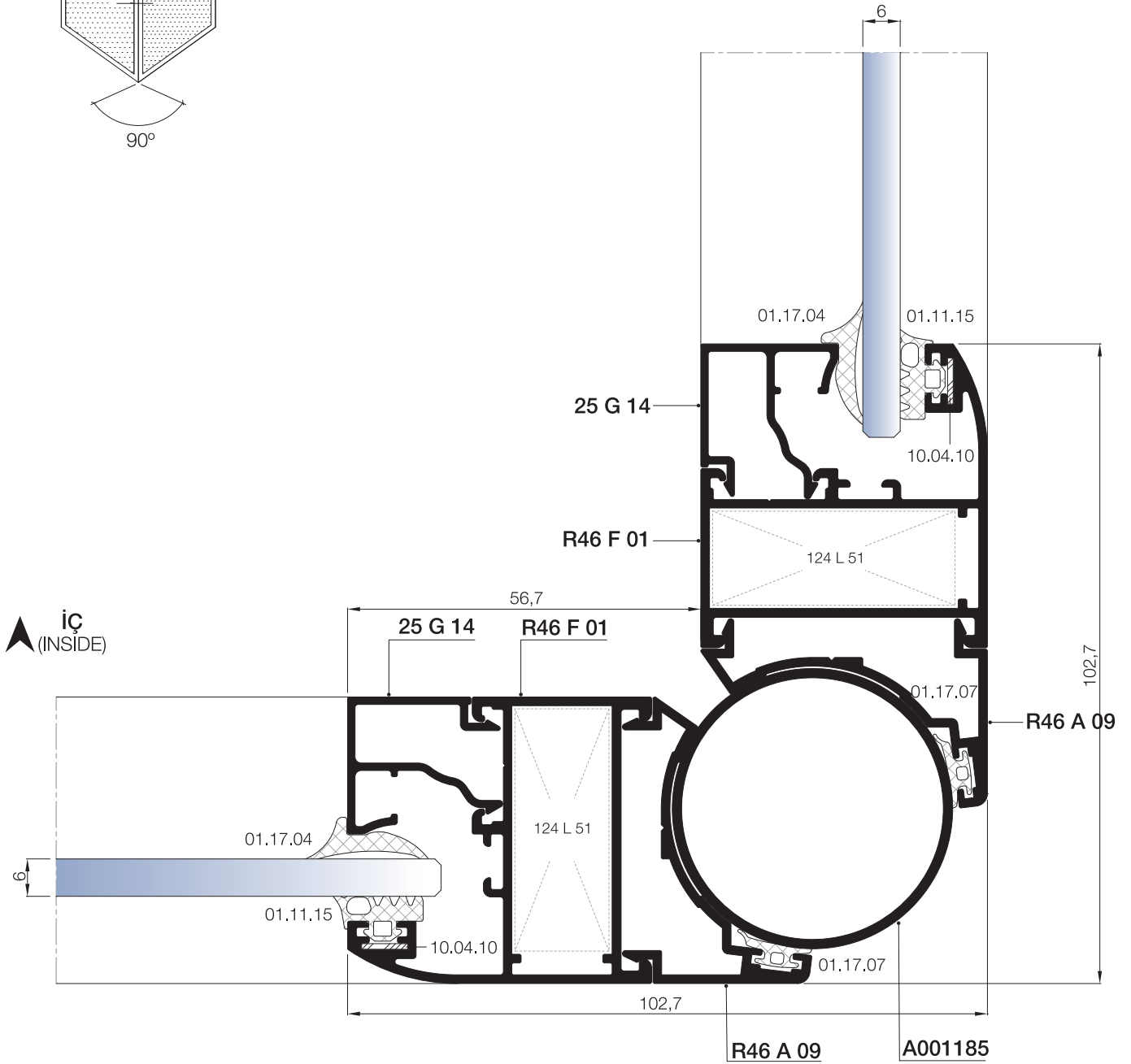

17 DETAYI
DETAIL

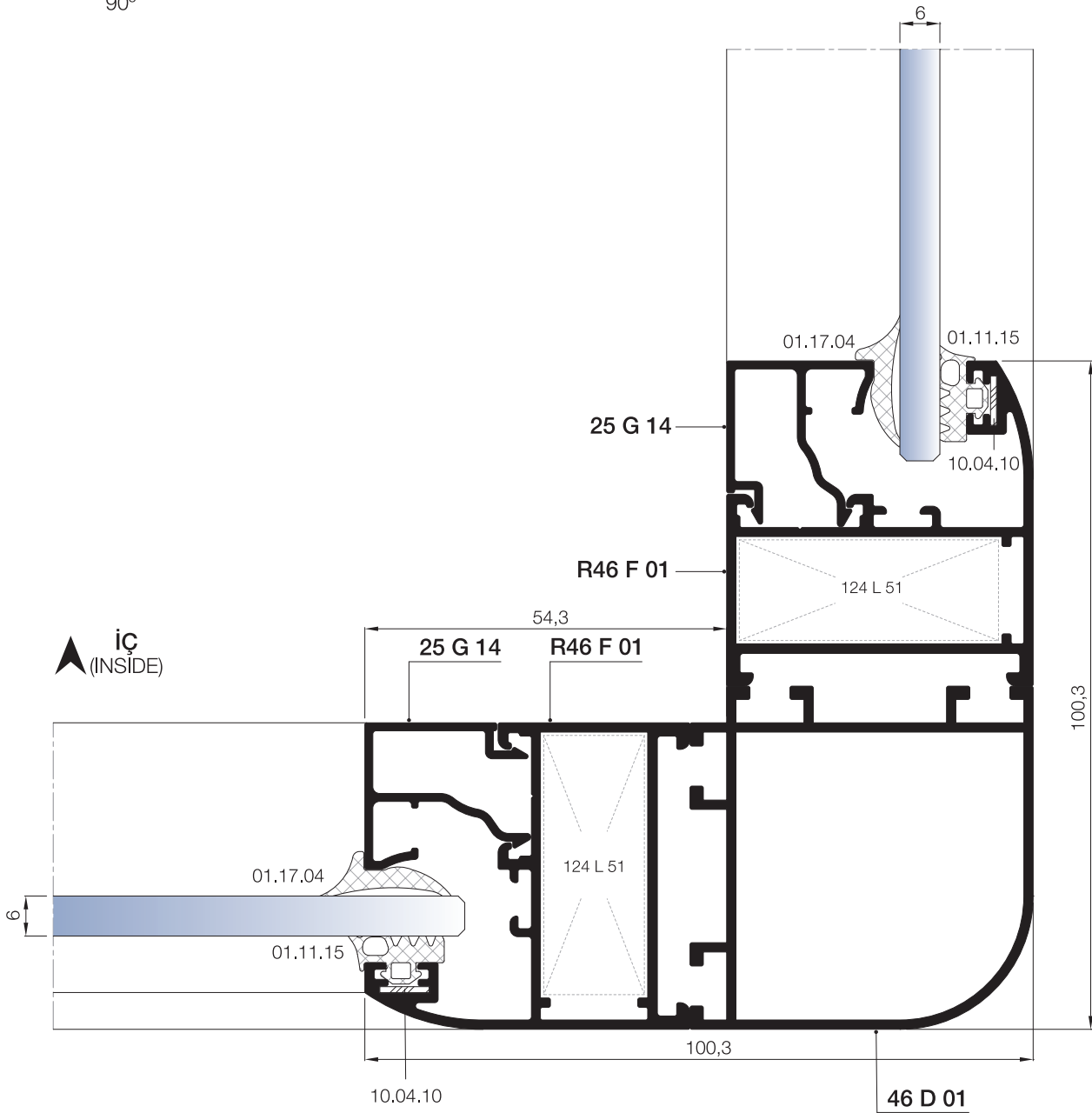
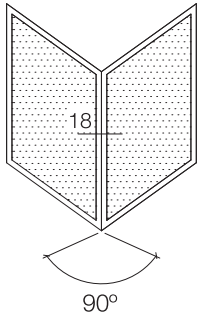

- 01
- 02
- 03
- 04
- 05
- 06
- 07
- 08
- 09
- 10

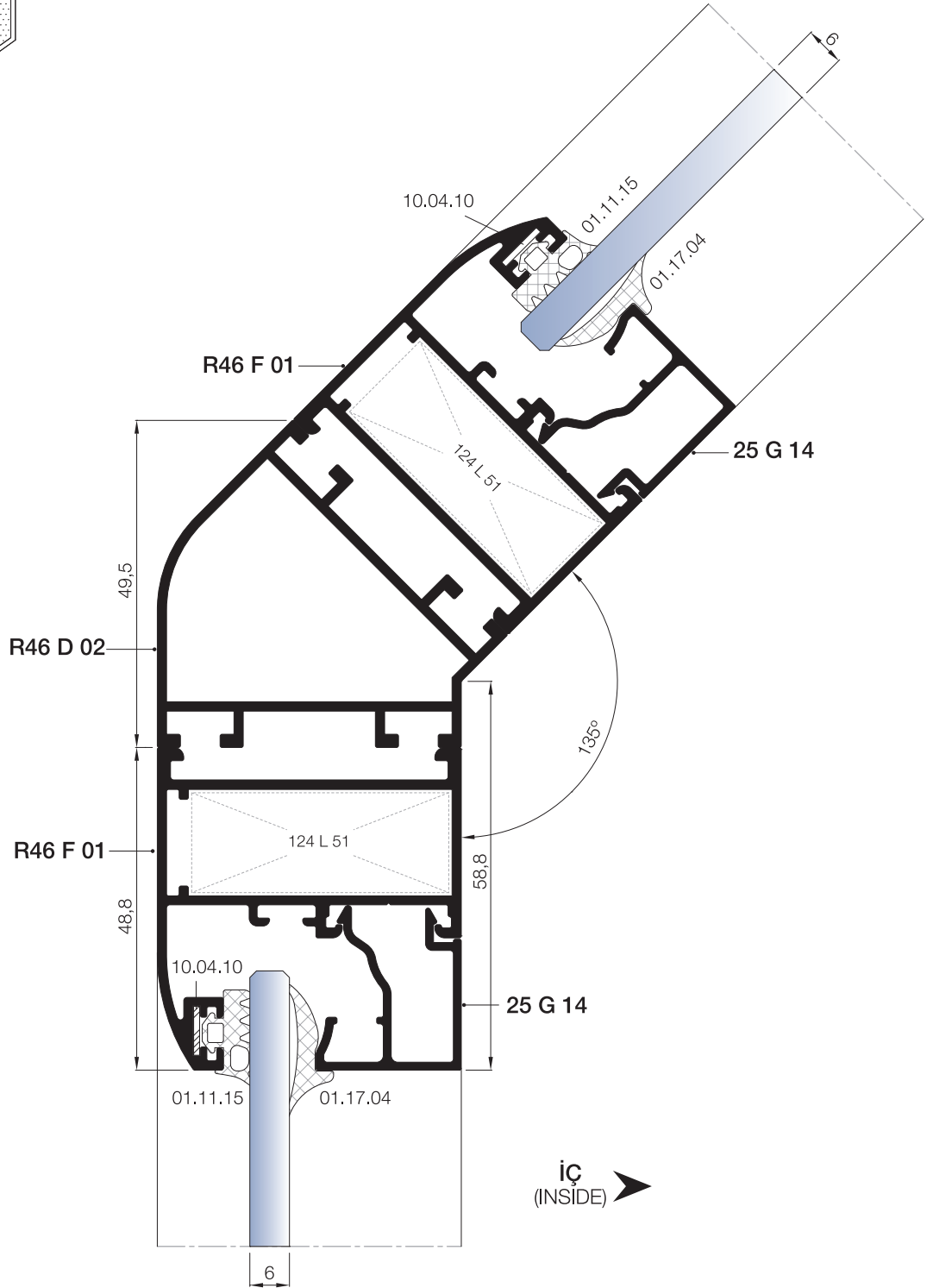
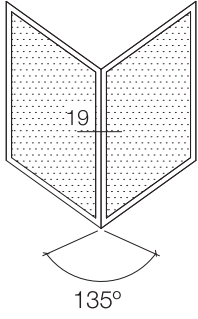

19 DETAYI
DETAIL

MİMARİ KATALOG ARCHITECTURAL CATALOGUE

Alüminyum Kapı Pencere ve Giydirme Cephe Sistemleri
Aluminium Window Doors and Facade Systems



Rescara Sistem Detayları
Rescara System Details

RW46

AKSESUARLAR

ACCESSORIES

01

02

03

04

05











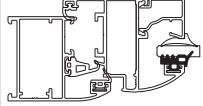



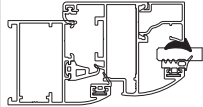

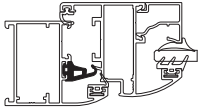
06

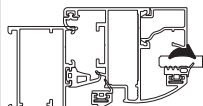
07

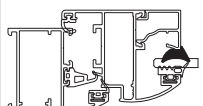
08

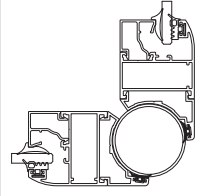
09

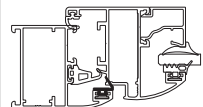
10

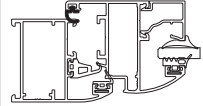
01		<p>01.11.15</p> <p>DIŞ CAM FİTİLİ OUTSIDE GLAZING GASKET 4mm</p> <p>Malzeme / Material : EPDM Ağırlık / Weight : 78 gr/m Paket / Package : 190 m / 15 kg</p>			<p>01.19.06</p> <p>ÇITA KANAL FİTİLİ ADAPTER GASKET</p> <p>Malzeme / Material : EPDM Ağırlık / Weight : 80 gr/m Paket / Package : 185 m / 15 kg</p>	
02						
03		<p>01.17.03</p> <p>İÇ CAM FİTİLİ 3mm boşluk için INSIDE GLAZING GASKET for 3mm space</p> <p>Malzeme / Material : EPDM Ağırlık / Weight : 60 gr/m Paket / Package : 250 m / 15 kg</p>			<p>01.19.21</p> <p>TOZLUK FİTİLİ CENTRAL GASKET</p> <p>Malzeme / Material : EPDM Ağırlık / Weight : 120 gr/m Paket / Package : 125 m / 15 kg</p>	
04		<p>01.17.04</p> <p>İÇ CAM FİTİLİ 4mm boşluk için INSIDE GLAZING GASKET for 4mm space</p> <p>Malzeme / Material : EPDM Ağırlık / Weight : 69 gr/m Paket / Package : 215 m / 15 kg</p>				
05						
06		<p>01.17.05</p> <p>İÇ CAM FİTİLİ 5mm boşluk için INSIDE GLAZING GASKET for 5mm space</p> <p>Malzeme / Material : EPDM Ağırlık / Weight : 90 gr/m Paket / Package : 165 m / 15 kg</p>				
07						
08		<p>01.17.07</p> <p>DIŞ BİNİ FİTİLİ OUTSIDE ACOUSTICAL GASKET</p> <p>Malzeme / Material : EPDM Ağırlık / Weight : 38 gr/m Paket / Package : 400 m / 15 kg</p>				
09		<p>01.18.03</p> <p>DIŞ BİNİ FİTİLİ OUTSIDE ACOUSTICAL GASKET</p> <p>Malzeme / Material : EPDM Ağırlık / Weight : 40 gr/m Paket / Package : 375 m / 15 kg</p>				
10		<p>01.18.04</p> <p>İÇ BİNİ FİTİLİ INSIDE ACOUSTICAL GASKET</p> <p>Malzeme / Material : EPDM Ağırlık / Weight : 40 gr/m Paket / Package : 375 m / 15 kg</p>				

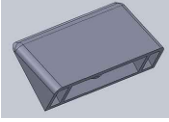
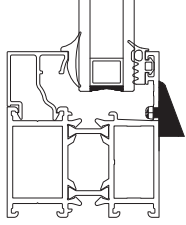
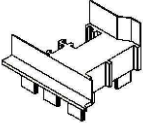
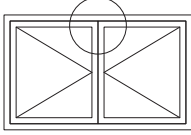
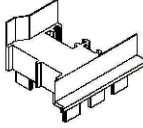
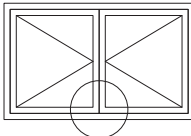
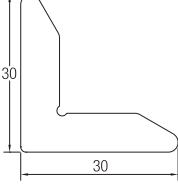
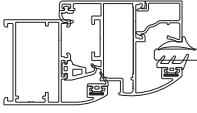
	04.02.07 TAHLİYE KAPAĞI DRAINAGE COVER Malzeme / Material : PVC Renk / Color : Siyah/Black				
	04.06.34 ADAPTÖR KAPAĞI ADAPTER CAP Malzeme / Material : PVC Renk / Color : Siyah/Black R46A02 için / For R46A02				
	04.05.35 ADAPTÖR KAPAĞI ADAPTER CAP Malzeme / Material : PVC Renk / Color : Siyah/Black R46A02 için / For R46A02	 USE WITH: R46 A 02			
	10.04.10 KÖŞE ÇAVUŞU CORNER PIECE Malzeme / Material : Paslanmaz Çelik/Stainless Steel				

01

02

03

04

05

06

07

08

09

10

PENCERE MENTEŞELERİ / WINDOW HINGES



15.01.16

GIESSE PENCERE MENTEŞESİ
GIESSE HINGE FOR WINDOWS

Renk / Color : Siyah-Beyaz-Gri-Eloksal
Black-White-Grey-Anodised

75 kg için 2 adet, 85 kg için 3 adet kullanılmalıdır. / Should be used 2 for 75 kg, 3 for 85 kg.
EN 1935:2002



15.01.03

RESCARA PENCERE MENTEŞESİ
HINGE FOR WINDOWS

Renk / Color : Siyah-Beyaz-Gri
Black-White-Grey

75 kg için 2 adet, 85 kg için 3 adet kullanılmalıdır. / Should be used 2 for 75 kg, 3 for 85 kg.
EN 1935:2002

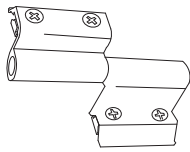

15.01.08

YERLİ PENCERE MENTEŞESİ
LOCAL HINGE FOR WINDOWS

Renk / Color : Siyah-Beyaz-Gri-Eloksal
Black-White-Grey-Anodised

50 kg için 2 adet kullanılmalıdır. / Should be used 2 for 50 kg.
Max. kanat ölçüsü 900x1300 / Max. vent dimension 900x1300
TS EN 1935

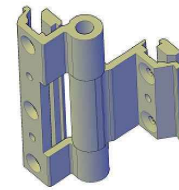

15.01.12

YERLİ PENCERE MENTEŞESİ
LOCAL HINGE FOR WINDOWS

Renk / Color : Siyah-Beyaz-Gri-Eloksal
Black-White-Grey-Anodised

TS EN 1935

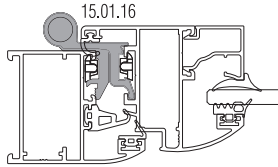

15.01.16

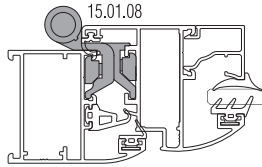

15.01.08

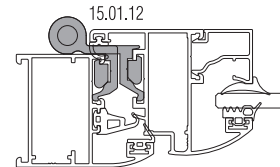

15.01.12

Ölçek/Scale: 1/3

KAPI MENTEŞELERİ / DOOR HINGES



15.02.14

GIESSE KAPI MENTEŞESİ
GIESSE HINGE FOR DOORS

Renk / Color : Siyah-Beyaz-Eloksal
Black-White-Anodised

100 kg için 2 adet, 120 kg için 3 adet kullanılmalıdır. / Should be used 2 for 100 kg, 3 for 120 kg.
EN 1935



15.02.09

YERLİ KAPI MENTEŞESİ
LOCAL HINGE FOR DOORS

Renk / Color : Siyah-Beyaz-Gri-Eloksal
Black-White-Grey-Anodised

85 kg için 3 adet kullanılmalıdır. / Should be used 3 for 85 kg.
Max. kanat ölçüsü 900x2200 / Max. vent dimension 900x2200
TS EN 1935

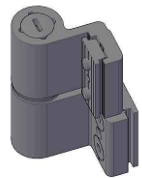

15.02.12

YERLİ KAPI MENTEŞESİ
LOCAL HINGE FOR DOORS

Renk / Color : Siyah-Beyaz-Gri-Eloksal
Black-White-Grey-Anodised

100 kg için 3 adet kullanılmalıdır. / Should be used 3 for 100 kg.
Max. kanat ölçüsü 900x2300 / Max. vent dimension 900x2300
TS EN 1935



15.02.07

YERLİ KAPI MENTEŞESİ
LOCAL HINGE FOR DOORS

Renk / Color : Siyah-Beyaz-Gri-Eloksal
Black-White-Grey-Anodised

100 kg için 2 adet kullanılmalıdır. / Should be used 2 for 100 kg.
Max. kanat ölçüsü 900x2200 / Max. vent dimension 900x2200
TS EN 1935

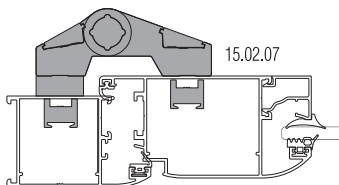

15.02.07

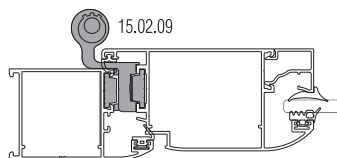

15.02.09

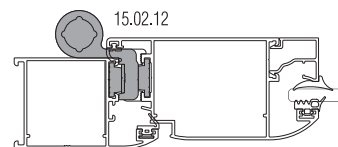

15.02.12

Ölçek/Scale: 1/3

ÇİFT EKSEN MEKANİZMALARI / TILT & TURN MECHANISM

			<p>GIESSE FUTURA ÇİFT AÇILIM SETİ 80 kg GIESSE TILT & TURN MECHANISM 80 kg</p> <p>Renk / Color : Siyah-Beyaz-Gri Black-White-Grey</p>	
	<p>GIESSE ÇİFT AÇILIM SETİ GIESSE TILT & TURN MECHANISM</p>	<p>KANAT GENİŞLİĞİ SASH WIDTH</p>	<p>KANAT YÜKSEKLİĞİ SASH HEIGHT</p>	<p>KANAT AĞIRLIĞI SASH WEIGHT</p>
07.06.62	410 - 569 mm	600 - 1200 mm	80 kg	Çift Açılım Seti Tip 1 / Tilt & Turn Mechanism Style 1
07.06.63	410 - 569 mm	1201 - 2500 mm	80 kg	Çift Açılım Seti Tip 1+ Arka Kilitleme / Tilt & Turn Mechanism Style 1+Additional Tilt&Turn (Back)
07.06.64	570 - 1000 mm	600 - 1200 mm	80 kg	Çift Açılım Seti Tip 2 / Tilt & Turn Mechanism Style 2
07.06.65	570 - 1000 mm	1201 -2500 mm	80 kg	Çift Açılım Seti Tip 2 + Arka Kilitleme / Tilt & Turn Mechanism Style 2+Additional Tilt&Turn (Back)
07.06.66	1001 - 1700 mm	600 - 1200 mm	80 kg	Çift Açılım Seti Tip 2 + Alt Kilitleme + İlave Makas / Tilt & Turn Mechanism Style 2+Additional Tilt&Turn (Down)+Additional Arm
07.06.67	1001 - 1700 mm	1201 - 2500 mm	80 kg	Çift Açılım Seti + Alt Kilitleme + Arka Kilitleme + İlave Makas / Tilt & Turn Mechanism+Additional Tilt&Turn (Down)+Additional Tilt & Turn (Back)+Additional Arm

			<p>GIESSE FUTURA ÇİFT AÇILIM SETİ 130 kg GIESSE TILT & TURN MECHANISM 130 kg</p> <p>Renk / Color : Siyah-Beyaz-Gri Black-White-Grey</p> <p>*** Stok Sorulmalıdır.</p>	
	<p>GIESSE ÇİFT AÇILIM SETİ GIESSE TILT & TURN MECHANISM</p>	<p>KANAT GENİŞLİĞİ SASH WIDTH</p>	<p>KANAT YÜKSEKLİĞİ SASH HEIGHT</p>	<p>KANAT AĞIRLIĞI SASH WEIGHT</p>
07.06.68	410 - 700 mm	600 - 1200 mm	130 kg	Çift Açılım Seti Tip 1 / Tilt & Turn Mechanism Style 1
07.06.69	410 - 700 mm	1201 - 3000 mm	130 kg	Çift Açılım Seti Tip 1+ Arka Kilitleme / Tilt & Turn Mechanism Style 1 + Additional Tilt&Turn (Back)
07.06.70	701 - 1000 mm	600 - 1200 mm	130 kg	Çift Açılım Seti Tip 2 / Tilt & Turn Mechanism Style 2
07.06.71	701 - 1000 mm	1201 - 3000 mm	130 kg	Çift Açılım Seti Tip 2 + Arka Kilitleme / Tilt & Turn Mechanism Style 2+ Additional Tilt&Turn (Back)
07.06.72	1001 - 1800 mm	600 - 1200 mm	130 kg	Çift Açılım Seti Tip 2+ İlave Makas + Alt Kilitleme / Tilt & Turn Mechanism Style 2+Additional Arm+Additional Tilt&Turn (Down)
07.06.73	1001 - 1800 mm	1201 - 3000 mm	130 kg	Çift Açılım Seti Tip 2+ İlave Makas + Alt Kilitleme + Arka Kilitleme / Tilt & Turn Mechanism Style 2+Additional Arm+Additional Tilt&Turn (Down)+Additional Tilt&Turn (Back)



07.06.60

İTHAL ÇİFT AÇILIM SETİ
TILT&TURN MECHANISM

Renk / Color : Siyah-Beyaz-Gri
Black-White-Grey

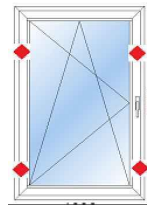





Kanat Genişliği: 570 - 1000 mm
Kanat Yüksekliği: 400 - 1200 mm

Sash Width: 570 - 1000 mm
Sash Height: 400 - 1200 mm

PENCERE KOLLARI / WINDOW HANDLES

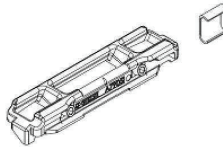
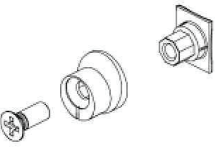
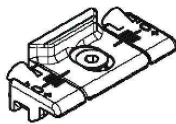
 <p>07.05.12 RESCARA İSPANYOLET (ÇİFT DİLLİ) HANDLE FOR WINDOWS (DOUBLE RAIL) Renk / Color : Siyah-Beyaz-Gri Black-White-Grey</p> <p>EN 1670</p>	 <p>07.05.25 GIESSE İSPANYOLET (ÇİFT DİLLİ) GIESSE HANDLE FOR WINDOWS (DOUBLE RAIL) Renk / Color : Siyah-Beyaz-Gri Black-White-Grey</p> <p>UNI CEI EN ISO / IEC 17050</p>
 <p>07.13.02 ORTA GÖBEK PİMİ CENTRAL LOCK PIN</p> <p>07.05.12 Kol için / For handle 07.05.12</p>	 <p>07.25.01 GIESSE TİJ BAĞLANTI PARÇASI GIESSE CONNECTION ROD Renk / Color : Siyah-Black Malzeme / Material : Polyamid-Polyamide</p> <p>07.05.25 Kol için / For handle 07.05.25</p>

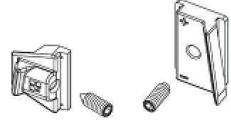
İSPANYOLET KİLİTLEME PARÇALARI / LOCKING KITS

 <p>18.03.08 GIESSE AYARLI SÜRGÜ GIESSE ADJUSTABLE BOLT Malzeme / Material: Zamak/Zamak</p> <p>EN 12051:2001</p>	 <p>18.06.01 GIESSE KARŞILIK GIESSE STRIKER Malzeme / Material: Paslanmaz Çelik ve Zamak Stainless Steel & Zamak</p>
 <p>07.13.06 GIESSE PİM GIESSE ADJUSTABLE LOCKING PAWL Malzeme / Material: Zamak/Zamak</p>	 <p>07.09.07 GIESSE AYARLI PİM KARŞILIĞI GIESSE ADJUSTABLE SINGLE STRIKER Malzeme / Material: Zamak/Zamak</p>
 <p>07.21.02 GIESSE KÖŞE DÖNME GIESSE CORNER DRIVE Malzeme / Material: Zamak/Zamak</p>	 <p>07.09.08 GIESSE ARKA KİLİTLEME GIESSE BURGLAR BOLT Malzeme / Material: Zamak/Zamak</p>
 <p>18.07.01 SÜRGÜ SETİ GIESSE BOLT FOR COMBINED WING Malzeme / Material: Zamak-Polyamid Zamak & Polyamide</p> <p>Pasif kanat için / For secondary sash</p>	

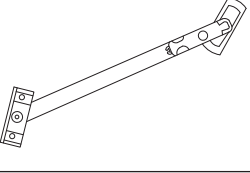
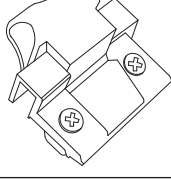
	<p>07.07.02</p> <p>VASİSTAS MAKAS ARM FOR BOTTOM-HUNG WINDOWS</p> <p>Renk / Color : Siyah-Beyaz-Gri Black-White-Grey</p>		<p>07.08.01</p> <p>VASİSTAS MANDAL DEVICE FOR CLOSING BOTTOM-HUNG WINDOWS</p> <p>Renk / Color : Siyah-Beyaz-Gri Black-White-Grey</p>
---	--	---	--

KOD CODE	AÇIKLAMA DESCRIPTION	***KOL VE KİLİTLEME SETİ SEÇİM TABLOSU HANDLE AND LOCKING KIT TABLE			
		L<1000 H<1200		L>1000 H>1200	
07.05.12	ÇİFT DİLLİ İSPANYOLET KOL DOUBLE RAIL HANDLE	1		1	
07.05.25	GIESSE ÇİFT DİLLİ KOL GIESSE DOUBLE RAIL HANDLE		1		1
07.13.02	ORTAGÖBEK PİMİ CENTRAL LOCK PIN	2		2	
07.25.01	GIESSE KOL BAĞLANTI PARÇASI GIESSE ROD CONNECTION PIECES		1		1
18.03.08	GIESSE AYARLANABİLİR SÜRGÜ GIESSE ADJUSTABLE BOLT	2	2		
18.06.01	GIESSE KARŞILIK GIESSE DOUBLE STRIKER	2	2		
07.21.02	GIESSE KÖŞE DÖNME PARÇASI GIESSE CORNER DRIVE			2	2
07.13.06	GIESSE PİM GIESSE ADJUSTABLE LOCKING PAWL			4	4
07.09.07	GIESSE AYARLI PİM KARŞILIĞI GIESSE ADJUSTABLE SINGLE STRIKER			4	4

*** Giesse kol ve kilitleme aksesuarları 25 I 07 tij profili ile kullanılmalıdır.

Giesse handle and locking accessories should be used with 25 I 07 rod profile

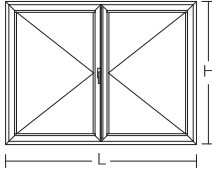









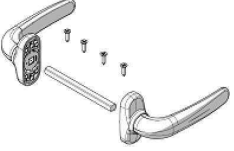
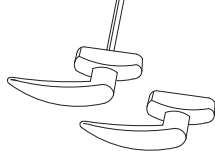

***KOL VE KİLİTLEME SETİ SEÇİM TABLOSU
HANDLE AND LOCKING KIT TABLE

		L<1000 H<1200		L>1000 H>1200	
KOD CODE	AÇIKLAMA DESCRIPTION	07.05.12 kol ile with 07.05.12 handle	07.05.25 kol ile with 07.05.25 handle	07.05.12 kol ile with 07.05.12 handle	07.05.25 kol ile with 07.05.25 handle
HAREKETLİ KANAT / FIRST SASH					
07.05.12	ÇİFT DİLLİ İSPANYOLET KOL DOUBLE RAIL HANDLE	1		1	
07.05.25	GIESSE ÇİFT DİLLİ KOL GIESSE DOUBLE RAIL HANDLE		1		1
07.13.02	ORTAĞÖBEK PİMİ CENTRAL LOCK PIN	2		2	
07.25.01	GIESSE KOL BAĞLANTI PARÇASI GIESSE ROD CONNECTION PIECES		1		1
18.03.08	GIESSE AYARLANABİLİR SÜRGÜ GIESSE ADJUSTABLE BOLT	2	2		
18.06.01	GIESSE KARŞILIK GIESSE DOUBLE STRIKER	2	2		
07.21.02	GIESSE KÖŞE DÖNME PARÇASI GIESSE CORNER DRIVE			2	2
07.13.06	GIESSE PİM GIESSE ADJUSTABLE LOCKING PAWL			4	4
07.09.07	GIESSE AYARLI PİM KARŞILIĞI GIESSE ADJUSTABLE SINGLE STRIKER			4	4
PASİF KANAT / SECONDARY SASH					
18.07.01	GIESSE SÜRGÜ SETİ GIESSE BOLT FOR SECONDARY SASH	1	1	1	1
07.09.08	GIESSE ARKA KİLİTLEME GIESSE BURGLAR BOLT			1	1

*** Giesse kol ve kilitleme aksesuarları 25 I 07 tij profili ile kullanılmalıdır.

Giesse handle and locking accessories should be used with 25 I 07 rod profile

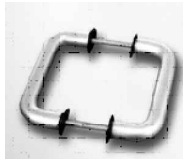
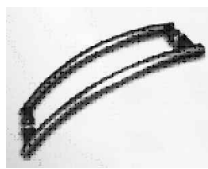
KAPI KOLLARI / DOOR HANDLES

 <p>07.14.06 GIESSE KAPI KOLU GIESSE DOOR HANDLE Renk / Color : Siyah-Beyaz-Gri Black-White-Grey</p>	 <p>07.14.04 KAPI KOLU DOOR HANDLE Renk / Color : Siyah-Beyaz-Gri Black-White-Grey</p>
 <p>07.17.02 D KAPI KOLU DOOR HANDLE Renk / Color : Siyah-Beyaz-Gri-Eloksal Black-White-Grey-Anodised Ölçüler / Dimensions: H: 40 cm / O: 2,5 cm</p>	 <p>07.17.06 V KAPI KOLU DOOR HANDLE Renk / Color : Siyah-Beyaz-Gri-Eloksal Black-White-Grey-Anodised Ölçüler / Dimensions: H: 20 cm / O: 2,5 cm</p>
 <p>07.17.08 U KAPI KOLU DOOR HANDLE Renk / Color : Siyah-Beyaz-Gri-Eloksal Black-White-Grey-Anodised Ölçüler / Dimensions: H: 40 cm / O: 2,5 cm</p>	 <p>07.17.10 D KAPI KOLU DOOR HANDLE Renk / Color : Siyah-Beyaz-Gri-Eloksal Black-White-Grey-Anodised Ölçüler / Dimensions: H: 20 cm / O: 2,5 cm</p>
 <p>07.17.11 D KAPI KOLU DOOR HANDLE Renk / Color : Siyah-Beyaz-Gri-Eloksal Black-White-Grey-Anodised Ölçüler / Dimensions: H: 30 cm / O: 2,5 cm</p>	 <p>07.17.19 AKBANK KAPI KOLU DOOR HANDLE Renk / Color : Siyah-Beyaz-Gri-Eloksal Black-White-Grey-Anodised Ölçüler / Dimensions: H: 200 cm</p>
 <p>07.17.20 YARIM AY BORU KOLU DOOR HANDLE Renk / Color : Siyah-Beyaz-Gri-Eloksal Black-White-Grey-Anodised Ölçüler / Dimensions: H: 30 cm / O: 2,5 cm</p>	 <p>07.17.21 U ÇEKME KOL DOOR HANDLE Renk / Color : Siyah-Beyaz-Gri-Eloksal Black-White-Grey-Anodised Ölçüler / Dimensions: H: 20 cm</p>
 <p>07.17.22 YAY KOL DOOR HANDLE Renk / Color : Siyah-Beyaz-Gri-Eloksal Black-White-Grey-Anodised Ölçüler / Dimensions: H: 50 cm</p>	 <p>07.17.23 BASTON KOL DOOR HANDLE Renk / Color : Siyah-Beyaz-Gri-Eloksal Black-White-Grey-Anodised Ölçüler / Dimensions: H: 90 cm / O: 2,5 cm</p>

01

02

03

04

05

06





07

08

09

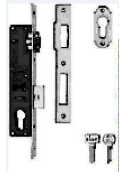
10

KAPI KİLİTLERİ / DOOR LOCKS

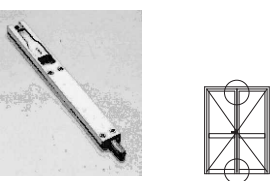
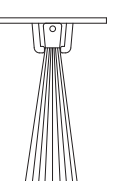
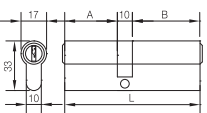
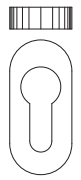
 <p>18.01.01 MAKARALI KİLİT MORTISE LOCK (WITH ROLLER)</p>	 <p>18.02.21 MAKARALI KİLİT KARŞILIĞI STRIKER ROLLER LOCK</p>						
 <p>18.01.02 DİLLİ KİLİT MORTISE LOCK</p>	 <p>18.02.20 DİLLİ KİLİT KARŞILIĞI STRIKER MORTISE LOCK</p>						
 <p>18.03.01 KAPI ALT ÜST KİLİTLEME BOLT FOR DOORS</p>	 <p>17.02.01 KAPI ALTI FIRÇASI BRUSH FOR DOORS Malzeme / Material : Polipropilen Polypropylene</p>						
 <p>18.04.03 BAREL CYLINDER Malzeme / Material : Krom-Nikel Chrome-Nickel</p> <table border="1" data-bbox="263 1310 391 1355"><thead><tr><th>A</th><th>B</th><th>L</th></tr></thead><tbody><tr><td>26</td><td>32</td><td>68</td></tr></tbody></table>	A	B	L	26	32	68	 <p>18.05.02 BAREL AYNASI CYLINDER COVER Renk / Color : Siyah-Beyaz Black-White</p>
A	B	L					
26	32	68					

